

LITEX

PROMO



Eco solutions
Éco solutions

PRODUCT CATALOG

valid from: 08/2023

CATALOGUE DE PRODUITS

valable à partir de : 08/2023

Content

Table des matières

1. New in the offer / Nouveau dans l'offre	3
2. Parasols	10
Beach Parasols.....	10
Eco Line.....	14
Easy Up.....	18
Classic.....	22
Telescopic.....	26
Strong.....	30
Giant.....	34
Rectangular.....	38
Side Leg RIO.....	42
Side Leg IBIZA.....	46
Atlantic.....	50
Easy To Transport.....	54
Easy Up - Easy To Transport.....	56
Telescopic - Easy To Transport.....	58
Harmony EcoWay.....	60
Bases / Pieds.....	64
Bases - summary / Pieds - résumé.....	66
Suspended advertising system / Système de publicité suspendu.....	68
Detachable wind valance / Bas-volets amovibles.....	69
Mobile system for parasol bases / Système mobile pour les pieds de parasol (RS550 / RS580 / RS600 / RS800).....	69
3. Awnings and terrace roofings / Marquises et auvents	72
Shade sail / Voile d'ombrage.....	74
Pergola Standard.....	75
Duetto Classic.....	76
Barcelona.....	77
California.....	78
Palermo.....	79
Roma.....	80
Andaluzja.....	81
4. Tents / Tentes	84
NEOtent™.....	86
5. Flags, banners, beachflags / Drapeaux, banderoles, beachflags	90
Banners / Banderoles.....	91
Beachflags.....	92
Flags / Drapeau.....	97
6. Textiles	98
Tablecloth / Nappes.....	100
Mesh tablecloth / Nappes en Mesh microperforé.....	100
Decorative cushions / Coussins décoratifs.....	101
Aprons / Tabliers de sommelier.....	101
Bartender's aprons / Tabliers de barman.....	101
7. Furniture and accessories / Meubles et accessoires	102
Deck chairs / Transats.....	103
Repost barrier post / Séparateurs REPOST.....	103
Aluminium deck chair / Transat en aluminium.....	104
Café barriers / Séparateurs de terrasse.....	106
8. Contact	109

Legend Légende

Meaning of the symbols used in the catalogue
Signification des symboles utilisés dans le catalogue

Printing techniques / Technique d'impression



digital printing, UV resistance up to 5 in accordance with ISO 105B-04
impression numérique, résistance aux UV jusqu'à 5 selon la norme ISO 105B-04



flat printing, UV resistance up to 7 in accordance with ISO 105B-04
impression à plat, résistance aux UV jusqu'à 7 selon la norme ISO 105B-04



hand screen printing, UV resistance up to 7 in accordance with ISO 105B-04
impression en sérigraphie manuelle, résistance aux UV jusqu'à 7 selon la norme ISO 105B-04



eco-solvent printing, UV resistance up to 7 in accordance with ISO 105B-04
impression à éco-solvant, résistance aux UV jusqu'à 7 selon la norme ISO 105B-04

Canopy finish / Finition de la tête du parasol



without valance
sans bas-volets



with vent
avec airvent

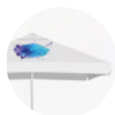

with valance
avec bas-volets



second roof
double toit

Type of fabric / Type de textile



woven fabric
toile tissée



nonwoven fabric
non-tissé



knitted fabric
toile tricotée



PVC



woven fabric
made of recycled yarn
tissu fabriqué à partir
de fils recyclés



Awnings
ANDALUZJA and ROMA

Marquise
ANDALUZJA et ROMA



ANDALUZJA

Cassette-free awning / Marquise sans cassette

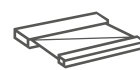

ROMA

Full-cassette awning / Marquise à cassette complète

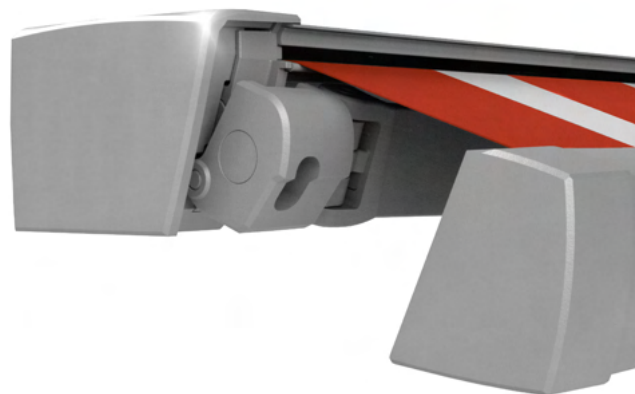
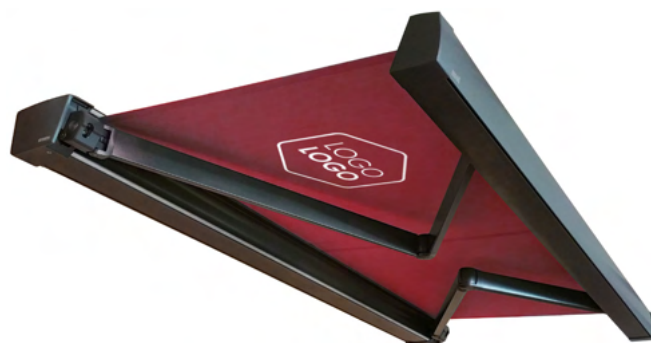

WHAT'S
NEW?

ALUMINIUM deck chair Transat en ALUMINIUM



WHAT'S
NEW?

New BEACHFLAG offer Nouvelle offre BEACHFLAG



+ new sizes of beachflags
nouvelles tailles de beachflag

+ new flag finishes
nouvelles finitions de drapeau

+ new model
nouveau modèle

+ new accessories
nouveaux accessoires

*The new base also fits our Beach Parasols! / La nouvelle base s'adapte également à nos Beach Parasols!

Why Litex Promo? Pourquoi nous choisir ?



Experience and reputation
Expérience et renommée

Our reputation in the industry is the best quality assurance of our services and products. Both small and medium-sized companies as well as global corporations work with us because they trust our experience and skills. We have been on the market for 30 years. During this time, we have managed to gain not only the trust of thousands of customers, but also a tremendous experience that allows us to create innovative solutions. We are not satisfied by mediocrity.

L'intégrité de nos pratiques et la fabrication responsable sont au cœur de notre démarche professionnelle. Le respect de ces principes est un gage de confiance et de réputation pour notre société et donne à nos clients la certitude d'une haute qualité de nos services et produits. Aussi bien les petites ou les moyennes entreprises que les grands groupes d'entreprises du monde entier travaillent avec nous, car ils ont confiance en notre expérience et savoir-faire. Nous sommes présents au marché depuis 30 ans. Pendant ce temps nous avons réussi à gagner non seulement la confiance de milliers de clients, mais aussi de l'expérience qui nous permet de créer de solutions novatrices. Nous ne sommes pas satisfaits de la médiocrité.



Cooperation and customer satisfaction
Coopération et satisfaction des clients

The best testimonial of our competence are the realizations for the largest brands. We know how important customer satisfaction is, that's why we use our experience, skills and technologies to continuously improve the quality of our services. All of our products are covered by a guarantee and their high quality is the certainty of a good investment.

Le meilleur certificat de nos compétences constituent des réalisations pour les plus grandes marques. Nous savons que la satisfaction de client est très importante, c'est pourquoi nous profitons de nos expérience, savoir-faire et technologies pour une amélioration constante de nos services. Tous nos produits sont couverts par la garantie et leur très haute qualité est la certitude d'un bon investissement.



Print quality
Qualité d'impression

We can say, in all confidence, that printing is our specialty. The extensiveness of our technical facilities allow us to offer customers various printing techniques, all tailored to their needs and the specificity of the project they want to implement. We have comprehensive competencies in digital printing, large format flatbed printing, rotary printing as well as manual screen printing. Our many years of experience in this industry assure you that the print on your product will be of the highest quality.

Nous pouvons déclarer avec confiance que l'impression est notre spécialité. Un large choix de possibilités techniques nous permet d'offrir aux clients de différentes techniques d'impression, tout selon la demande et la spécificité de projet qu'ils désirent réaliser. Nous possédons des compétences en impression numérique, impression à plat, impression rotative et sérigraphie manuelle. Nos nombreuses années d'expérience dans ce domaine vous donne la certitude que l'impression sur votre produit sera de meilleure qualité.

Printing Impression

	Screen printing Sérigraphie		
	Flat printing à plat	Rotary printing Rotative	Manual printing Manuelle
Print width [m] Largeur d'impression [m]	2,45	2,45	–
Number of colours Nombre de couleurs	7	1	5
UV resistance Résistance aux UV	up to 7 acc. to 105B-04 Jusqu'à 7 selon 105B-04	up to 7 acc. to 105B-04 Jusqu'à 7 selon 105B-04	up to 7 acc. to 105B-04 Jusqu'à 7 selon 105B-04
Advantages Avantages	Possibility of printing large formats Possibilité d'impression des graphiques grand format	The best method for printing the fabric in a full-colour (continuous model) Méthode idéale pour l'impression en couleur unie (motif en continu)	Possibility of printing on the dyed fabric Possibilité d'impression sur le tissu coloré
	The high coefficient of UV resistance Haute résistance aux rayons UV	The high quality of the fabrics reprints Haute qualité de réimpression de tissu (côté verso)	Possibility to produce small series Possibilité d'impression de petits volumes
	The high printing productivity for large series Grand rendement d'impression pour l'impression de hauts volumes	The high printing productivity for large series Grand rendement d'impression pour l'impression de hauts volumes	The high coefficient of UV resistance Haute résistance aux rayons UV

	Digital printing Impression numérique	
	Eco-solvent À éco-solvant	Sublimation
Print width [m] Largeur d'impression [m]	3,2	2,4
Number of colours Nombre de couleurs	CMYK	
UV resistance Résistance aux UV	up to 7 acc. to 105B-04 jusqu'à 7 selon 105B-04	up to 5 acc. to 105B-04 jusqu'à 5 selon 105B-04
Advantages Avantages	Expressive, vivid colors Couleurs expressives et vives	
	High resolution of the print Haute résolution de l'impression	
	Short period of the printing's preparation Processus de préparation à l'impression très rapide	



Corporate Social Responsibility La responsabilité sociétale des entreprises

We have undertaken action to reduce our impact on the natural environment. Recently, we have introduced innovative recycled yarn to manufacture advertising media, we also actively contribute to environmental protection. Our approach is not limited to the processing of PET bottles for rPet yarn production, but we also aim to reduce the consumption of non-renewable raw materials and eliminate harmful emissions into the atmosphere in our production plants.

Therefore, we are proud to inform that **all parts of our umbrellas**: aluminum frame, polyester and acrylic covers, **can be recycled**. The information diagram illustrating the recycling method is attached to the product at the customer's request. In addition to this, the plastic waste generated during the production cycle is processed and reused again.

Nous avons pris des mesures pour réduire notre impact sur l'environnement naturel. Récemment, nous avons introduit un fil recyclé innovant pour la production de supports publicitaires, nous contribuons également activement à la protection de l'environnement. Notre approche ne se limite pas au traitement de bouteilles PET pour la production de fil rPet, mais nous nous efforçons également de réduire la consommation de matières premières non renouvelables et d'éliminer les émissions nocives dans l'atmosphère dans nos usines de production.

Par conséquent, nous sommes fiers d'annoncer que **toutes les pièces de nos parasols** : mât en aluminium, toile en polyester et acrylique **peuvent être recyclées**. Le schéma d'information illustrant le mode de recyclage est joint au produit à la demande du client. De plus, les déchets plastiques générés pendant le cycle de production sont recyclés et réutilisés.



Recycling polyester fabric Recyclage des tissus en polyester



How do we reuse PET material? Comment utilisons-nous le matériel PET ?



Product offer made of rPet Offre de produits en rPet

As part of the rPet product range, we are able to provide certificates confirming that the products come from the recycling process. Additionally, labels on our products or other characteristic markings bear the word „recycled“.

Dans le cadre de la gamme de produits rPet, nous sommes en mesure de fournir des certificats confirmant que les produits proviennent du processus de recyclage. De plus, les étiquettes de nos produits ou autres marquages caractéristiques portent la mention « recyclé ».

Promotional parasols of the „rPET“ series are made of not less than 65% of all recycled materials, including: the share of recycled yarn in the sheathing - 100% and recycled aluminum in the frame - 90%.



Les parasols publicitaires de la série „rPET“ sont composés d'au moins 65% de tous les matériaux recyclés, dont : la part de fil recyclé dans la toile - 100% et d'aluminium recyclé dans le mât - 90%.

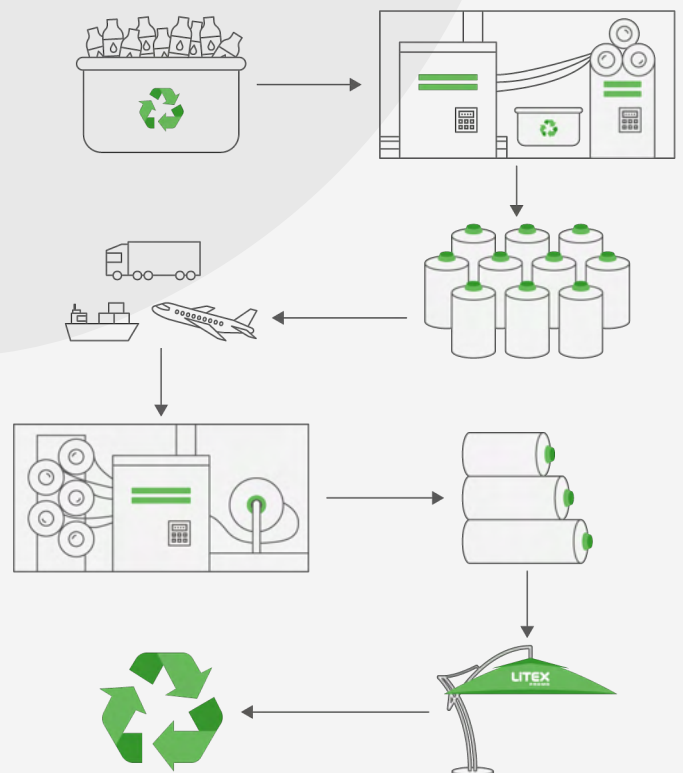



Beach Parasols





When lightness and mobility are most essential, nothing compares to Beach Parasols line. It is attractively priced and popular way to promote your brand. Thanks to their compact dimensions and low weight, the parasols are easy to set up and storage. These parasols are perfect for beach, balcony and garden. In addition, you can individually set the parasol according to the sun thanks to the tilt option.

Lorsque la légèreté et la mobilité sont essentielles, rien ne se compare à la ligne Beach Parasols. C'est une proposition attrayante et populaire pour promouvoir votre marque. Grâce à leurs dimensions compactes et leur faible poids, les parasols sont faciles à installer et à ranger. Ces parasols sont parfaits pour la plage, le balcon et le jardin. De plus, le mât inclinable permet d'orienter la tête du parasol en fonction du soleil.



Beach Parasols

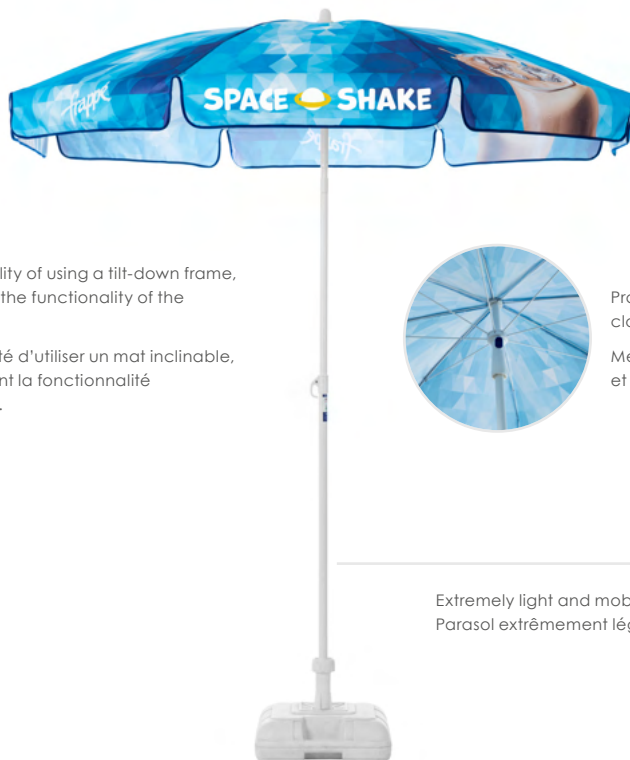

The possibility of using a tilt-down frame, increasing the functionality of the parasol.

La possibilité d'utiliser un mat inclinable, augmentant la fonctionnalité du parasol.



Practical mechanism for opening and closing the canopy for easy operation.

Mécanisme pratique pour ouvrir et fermer le parasol, utilisation facile.

Extremely light and mobile sunshade for the beach and garden.
Parasol extrêmement léger et mobile pour la plage et le jardin.



Size Taille	1,25 x 1,25 m	1,35 x 1,35 m	1,8 x 1,8 m	1,8 m / 8	2 x 2 m	2 m / 8
Dimensions [mm]	A: 1250 (max)* B: 2300 (max)* C: - D: - E: 2300 (max)*	A: 1350 (max)* B: 2300 (max)* C: - D: - E: 2300 (max)*	A: 1800 (max)* B: 2450 (max)* C: - D: - E: 2450 (max)*	A: 1800 (max)* B: 2300 (max)* C: - D: - E: 2300 (max)*	A: 2000 (max)* B: 2700 (max)* C: - D: - E: 2700 (max)*	A: 2000 (max)* B: 2300 (max)* C: - D: - E: 2300 (max)*

*adjustable height / hauteur réglable

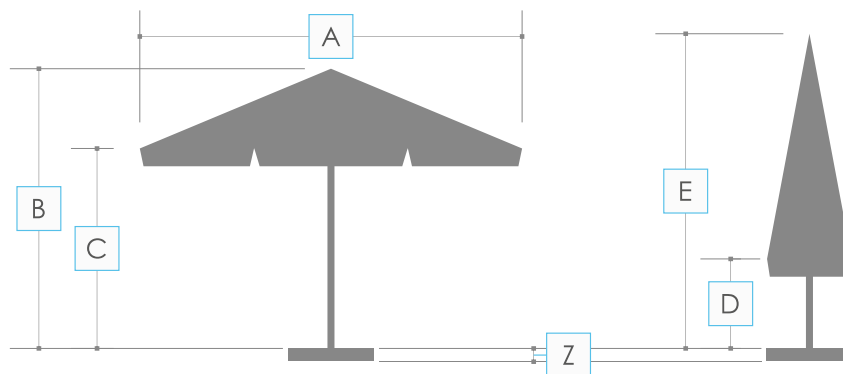

The Z value is the usable height of the base which, if used, must be added to the B and E values of the parasol. The value is available on pages 66-67.
La valeur Z est la hauteur utilisable de la base, qui, si elle est utilisée, doit être ajoutée aux valeurs B et E du parasol. Vous pouvez trouver la valeur aux pages 66-67.

Printing techniques / Technique d'impression



digital printing
impression numérique



flat printing
impression à plat

Canopy finish / Finition de la tête du parasol



with valance
avec bas-volets



without valance
sans bas-volets

Type of fabric / Type de textile



woven fabric
toile tissée



knitted fabric
toile tricotée



Size Taille	1,25 x 1,25 m	1,35 x 1,35 m	1,8 x 1,8 m	1,8 m / 8	2 x 2 m	2 m / 8
Tilt options Types de monture	with or without tilt inclinable ou fixe	with tilt inclinable	with tilt inclinable	with or without tilt inclinable ou fixe	with tilt inclinable	with tilt inclinable

	Canopy finish Finition de la tête du parasol					
Vent Airvent	-					
Without vent Sans airvent	as a standard en standard					
Second roof Double toit	-					

Type and colour of frame Type et couleur de monture	steel, white en acier, blanche					
Number of ribs Nombre des baleines	8	8	4	8	4	8
Type of base Types de pieds	BKR, PB370R15 / 25, PD510	BKR, PB370R15 / 25, PD510	BKR, ADRIATIC, PB370R15 / 25, PD510	BKR, PB370R15 / 25, PD510	ADRIATIC, PB370R15 / 25, PD510	BKR, PB370R15 / 25, PD510
Pole diameter [mm] Diamètre du mât [mm]	22 / 25	22 / 25	22 / 25	22 / 25	27 / 30	22 / 25

Optional / En option :

- + IBO frame (with profiled ribs)
Mât IBO (avec baleines paragonales)



Eco Line



Pizza Paolo



Pizza Paolo

Pizza Paolo



7,9 m/s
28 km/h



Eco Line parasols are a perfect marketing tool for building brand visibility. Lightweight aluminum frame and a two-part mast not only saves space when storing, but also contributes to much more economical transport. Canopy of the parasol can be printed entirely, and our technical background and many years of experience in this industry assure you that the print will be of the highest quality.

Les parasols Eco Line constituent un outil de marketing idéal pour renforcer la visibilité de la marque. Une structure en aluminium léger et un mât en deux parties permettent non seulement de gagner de l'espace lors du stockage, mais contribuent également à un transport beaucoup plus économique. La toile du parasol peut être entièrement imprimée et nos possibilités techniques et notre longue expérience dans ce secteur vous assurent la meilleure qualité d'impression.



Eco Line



Check out how to open this parasol
Voir comment ouvrir ce parasol

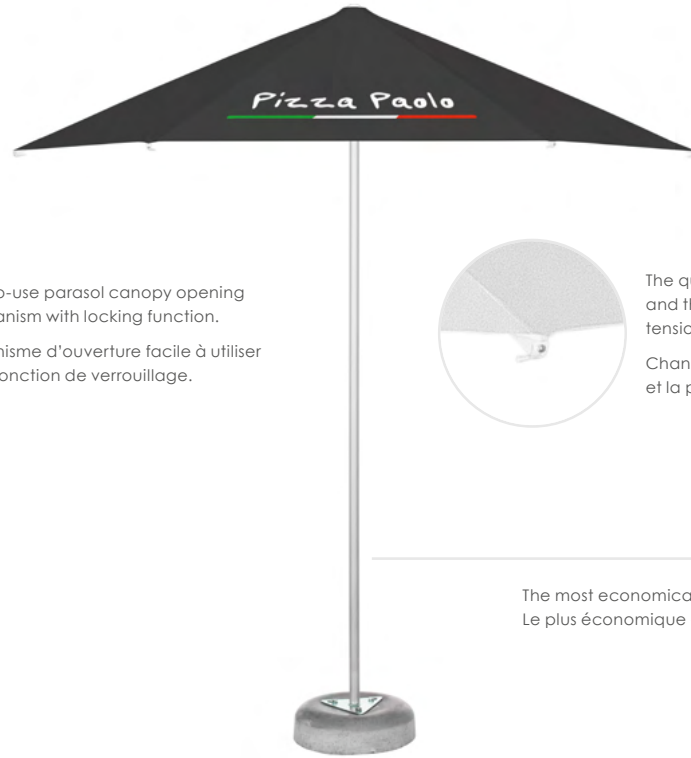

Easy-to-use parasol canopy opening mechanism with locking function.
Mécanisme d'ouverture facile à utiliser avec fonction de verrouillage.

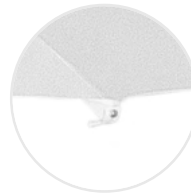

The quick-change system of the cover and the possibility of adjusting its tension.
Changement de la toile rapide et la possibilité de régler sa tension.

The most economical and compact of the parasols.
Le plus économique et compact des parasols.



Size Taille	2 m / 6	2,5 m / 8
Dimensions [mm]	A: 2000 B: 2510 C: 2080 D: 1430 E: 2510 F: 995	A: 2500 B: 2450 C: 2030 D: 1150 E: 2450

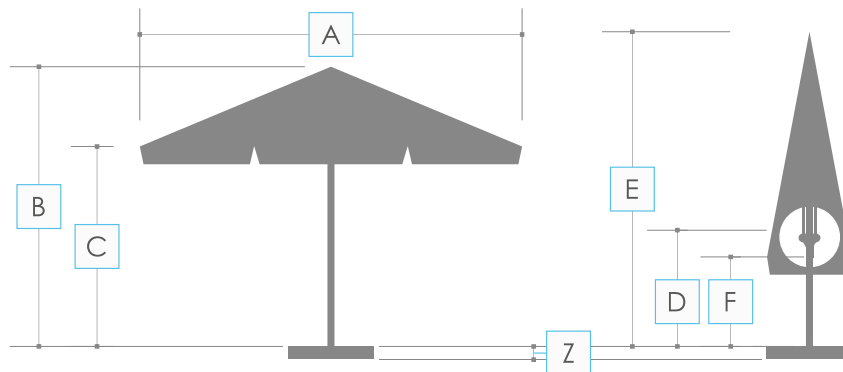

The Z value is the usable height of the base which, if used, must be added to the B and E values of the parasol. The value is available on pages 66-67.
La valeur Z est la hauteur utilisable de la base, qui, si elle est utilisée, doit être ajoutée aux valeurs B et E du parasol. Vous pouvez trouver la valeur aux pages 66-67.

Printing techniques / Technique d'impression



digital printing
impression numérique



flat printing
impression à plat



hand screen printing
impression en sérigraphie manuelle

Canopy finish / Finition de la tête du parasol



with valance
avec bas-volets



without valance
sans bas-volets

Type of fabric / Type de textile



woven fabric
toile tissée



woven fabric made of recycled yarn
(as an option)
tissu fabriqué à partir de fils recyclés
(en option)



Size Taille	2 m / 6	2,5 m / 8
Opening system Types de monture	skip bouton-poussoir	

	Canopy finish Finition de la tête du parasol	
Vent Airvent	-	
Without vent Sans airvent	as a standard en standard	
Second roof Double toit	-	

Type and colour of frame Type et couleur de monture	aluminum, white en aluminium, blanche	
Number of ribs Nombre des baleines	6	8
Type of base Types de pieds	PD450M, PD550RS	
Permissible maximum wind speed Vitesse maximale admissible du vent	7,9 m/s (28 km/h)	
Pole diameter [mm] Diamètre du mât [mm]	38	

Optional / En option :

- + Mobile set for parasol bases
Système mobile pour les pieds



Easy Up

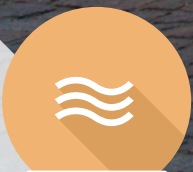

7,9-10,7 m/s
28-38 km/h

The background image shows a ship's deck with various equipment, including a radar scanner and lifebuoys. In the foreground, there are wooden chairs and a cobblestone ground. An orange semi-transparent rectangle is overlaid on the image, containing two paragraphs of text in white.

Easy Up is a line of parasols with a convenient and intuitive opening system. Just push the special handle up and secure the canopy. This simple method and wide range of available sizes make the parasols in this line perfect for gardens, hotel patios as well as beer gardens. The parasol's canopy, offered in the shape of a circle or square, makes it the ideal medium to promote your brand.

Easy Up est une gamme de parasols avec un système d'ouverture pratique et intuitif. Il suffit de pousser une spéciale poignée vers le haut et de sécuriser la tête du parasol. Grâce à cette simple méthode ainsi qu'à une vaste gamme de tailles, ces parasols sont très populaires dans les jardins, les patios des hôtels et les brasseries. La toile du parasol, disponible en forme ronde ou carrée, constitue un support idéal pour promouvoir votre marque.



Easy Up



Check out how to open this parasol
Voir comment ouvrir ce parasol



Convenient and intuitive system of opening with a safe handle.
Système d'ouverture pratique et intuitif avec poignée.



Possibility of efficient closure and securing of the parasol canopy.
Possibilité de fermeture et de sécurisation efficace de la tête du parasol.

The most popular parasol model among restaurateurs and beer garden owners.

Le modèle de parasol le plus populaire parmi les restaurateurs.



Size Taille	2 x 2 m	2,5 x 2,5 m	3 x 3 m	3 m / 8	3,5 m / 8	4 m / 8
Dimensions [mm]	A: 2000 B: 2350 C: 2000 D: 750 E: 2350	A: 2500 B: 2600 C: 2000 D: 800 E: 2600	A: 3000 B: 2800 C: 2050 D: 600 E: 2800	A: 3000 B: 2600 C: 2150 D: 1000 E: 2600	A: 3500 B: 2600 C: 2020 D: 1000 E: 2600	A: 4000 B: 2800 C: 2110 D: 720 E: 2800

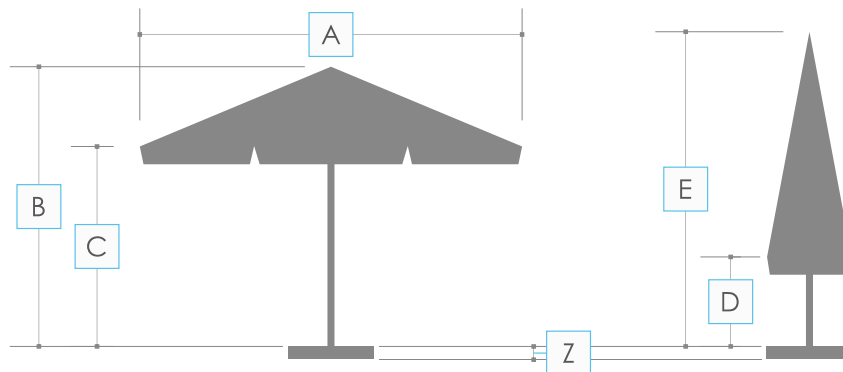

The Z value is the usable height of the base which, if used, must be added to the B and E values of the parasol. The value is available on pages 66-67.

La valeur Z est la hauteur utilisable de la base, qui, si elle est utilisée, doit être ajoutée aux valeurs B et E du parasol. Vous pouvez trouver la valeur aux pages 66-67.

Printing techniques / Technique d'impression



digital printing
impression numérique



flat printing
impression à plat



hand screen printing
impression en sérigraphie manuelle

Canopy finish / Finition de la tête du parasol



with valance
avec bas-volets



without valance
sans bas-volets



with vent
avec airvent

Type of fabric / Type de textile



woven fabric
toile tissée



woven fabric made of recycled yarn
(as an option)
tissu fabriqué à partir de fils recyclés
(en option)



Size Taille	2 x 2 m	2,5 x 2,5 m	3 x 3 m	3 m / 8	3,5 m / 8	4 m / 8
Opening system Types de monture	easyslift poignée					

	Canopy finish Finition de la tête du parasol					
Vent Airvent	-	as option en option	as a standard en standard	as option en option	as option en option	as option en option
Without vent Sans airvent	as a standard en standard	as a standard en standard	as option en option	as a standard en standard	as a standard en standard	as a standard en standard
Second roof Double toit	-					

Type and colour of frame Type et couleur de monture	aluminum, white en aluminium, blanche					
Number of ribs Nombre des baleines	4	4	4 or 8 4 ou 8	8	8	8
Type of base Types de pieds	PD450M, PD550RS	PD600RS, PD600RSD, PDZ	PD600RS, PD600RSD, PDZ	PD600RS, PD600RSD, PDZ	PD600RS, PD600RSD, PDZ	PD700MR, PDZ
Permissible maximum wind speed Vitesse maximale admissible du vent	7,9 m/s (28 km/h)	10,7 m/s (38 km/h)	4: 7,9 m/s (28 km/h) 8: 10,7 m/s (38 km/h)	10,7 m/s (38 km/h)	10,7 m/s (38 km/h)	10,7 m/s (38 km/h)
Pole diameter [mm] Diamètre du mât [mm]	40	50	50	50	50	50

Optional / En option :

+ Mobile set for parasol bases
Système mobile pour les pieds

+ Protective cover
Housse de parasol

+ Rain gutters
Gouttières



Classic



10.7 m/s
38 km/h

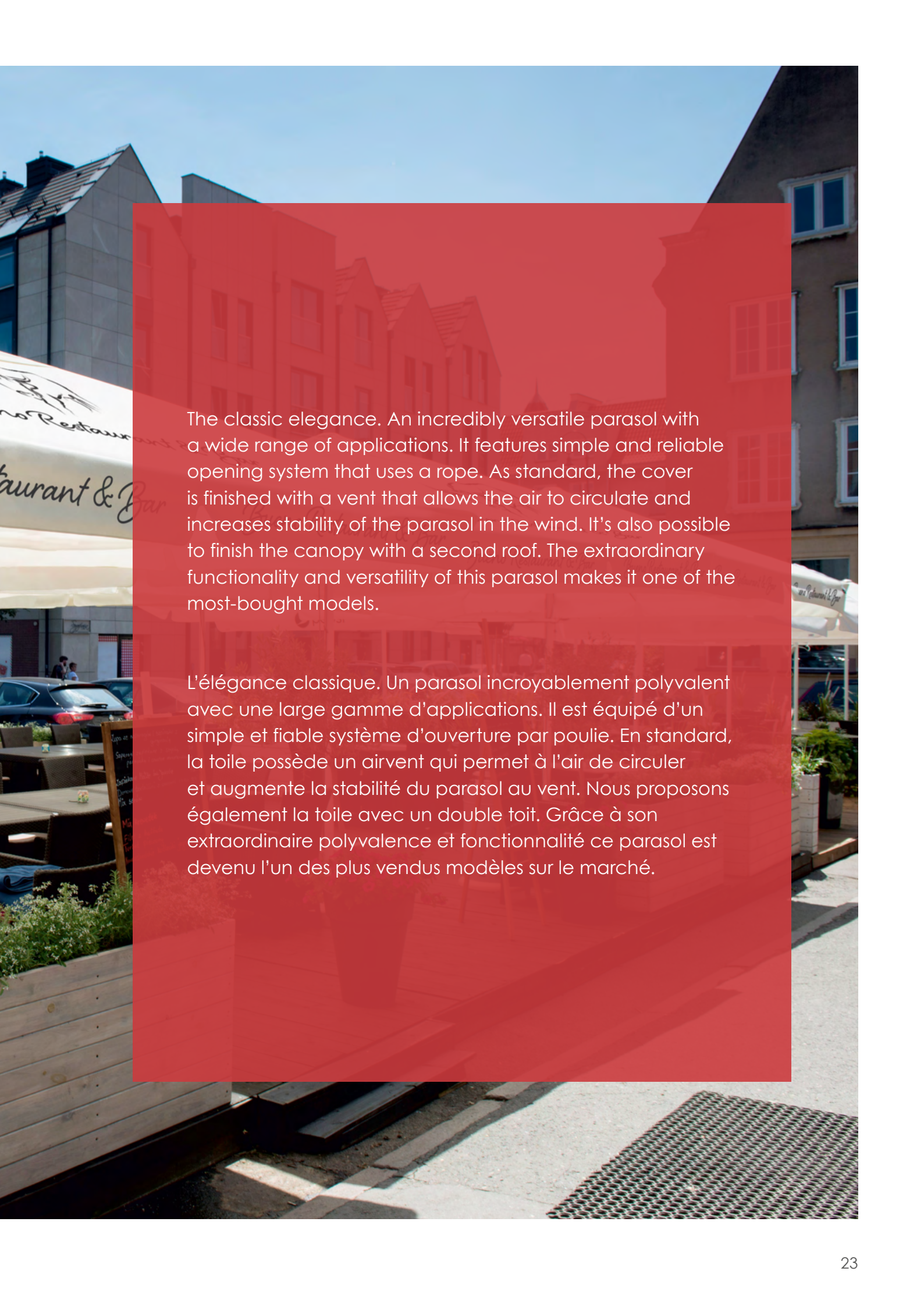

The classic elegance. An incredibly versatile parasol with a wide range of applications. It features simple and reliable opening system that uses a rope. As standard, the cover is finished with a vent that allows the air to circulate and increases stability of the parasol in the wind. It's also possible to finish the canopy with a second roof. The extraordinary functionality and versatility of this parasol makes it one of the most-bought models.

L'élégance classique. Un parasol incroyablement polyvalent avec une large gamme d'applications. Il est équipé d'un simple et fiable système d'ouverture par poulie. En standard, la toile possède un airvent qui permet à l'air de circuler et augmente la stabilité du parasol au vent. Nous proposons également la toile avec un double toit. Grâce à son extraordinaire polyvalence et fonctionnalité ce parasol est devenu l'un des plus vendus modèles sur le marché.



Classic



Check out how to open this parasol
Voir comment ouvrir ce parasol



Comfortable operation thanks to the classic string mechanism.

Utilisation confortable grâce au mécanisme d'ouverture classique par poulie.

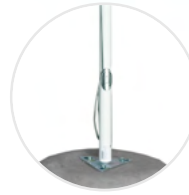

Pole structure optimized for open-close manual operation by a string.

La conception du mât est optimisée pour l'ouverture du parasol par poulie.

Classic model of a sunshade parasol for universal use.
Modèle classique d'un parasol à usage universel.



Size Taille	3 x 3 m	3,5 x 3,5 m	4 x 4 m	4 m / 8
Dimensions [mm]	A: 3000 B: 2800 C: 2100 D: 635 E: 2800	A: 3500 B: 3000 C: 2160 D: 440 E: 3000	A: 4000 B: 3150 C: 2270 D: 250 E: 3150	A: 4000 B: 3000 C: 2000 D: 780 E: 3000

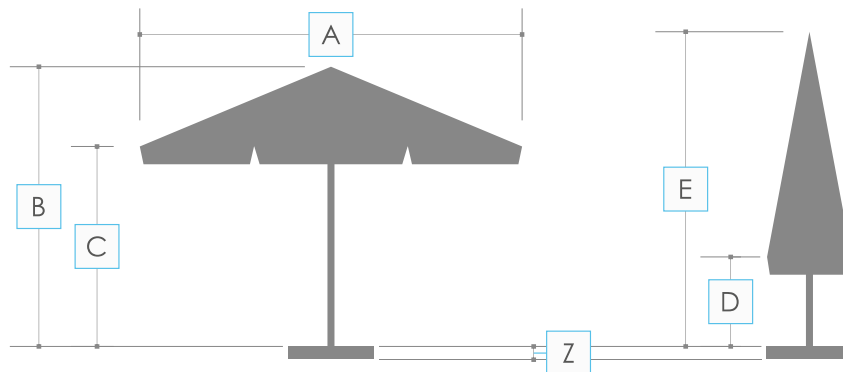

The Z value is the usable height of the base which, if used, must be added to the B and E values of the parasol. The value is available on pages 66-67.
La valeur Z est la hauteur utilisable de la base, qui, si elle est utilisée, doit être ajoutée aux valeurs B et E du parasol. Vous pouvez trouver la valeur aux pages 66-67.

Printing techniques / Technique d'impression



digital printing
impression numérique



flat printing
impression à plat



hand screen printing
impression en sérigraphie manuelle

Canopy finish / Finition de la tête du parasol



with valance
avec bas-volets



without valance
sans bas-volets



with vent
avec airvent

Type of fabric / Type de textile



woven fabric
toile tissée



woven fabric made of recycled yarn
(as an option)
tissu fabriqué à partir de fils recyclés
(en option)



Size Taille	3 x 3 m	3,5 x 3,5 m	4 x 4 m	4 m / 8
Opening system Types de monture	rope poulie			

	Canopy finish Finition de la tête du parasol			
Vent Airvent	as a standard en standard	as a standard en standard	as a standard en standard	as a standard en standard
Without vent Sans airvent	as option en option	-	-	-
Second roof Double toit	-	-	as option en option	-

Type and colour of frame Type et couleur de monture	aluminum, white en aluminium, blanche			
Number of ribs Nombre des baleines	8			
Type of base Types de pieds	PD600RS, PD600RSD, PDZ	PD700MR, PDZ	PDU-B40, PDZ	PD700MR, PDZ
Permissible maximum wind speed Vitesse maximale admissible du vent	10,7 m/s (38 km/h)			
Pole diameter [mm] Diamètre du mât [mm]	50	60	60	60

Optional / En option :

- + Mobile set for parasol bases
Système mobile pour les pieds
- + Protective cover
Housse de parasol
- + Rain gutters
Gouttières
- + Walls
Parois
- + Detachable wind valance for sunshade parasols
Bas-volets amovibles pour les parasols



10.7 m/s
38 km/h



Telescopic

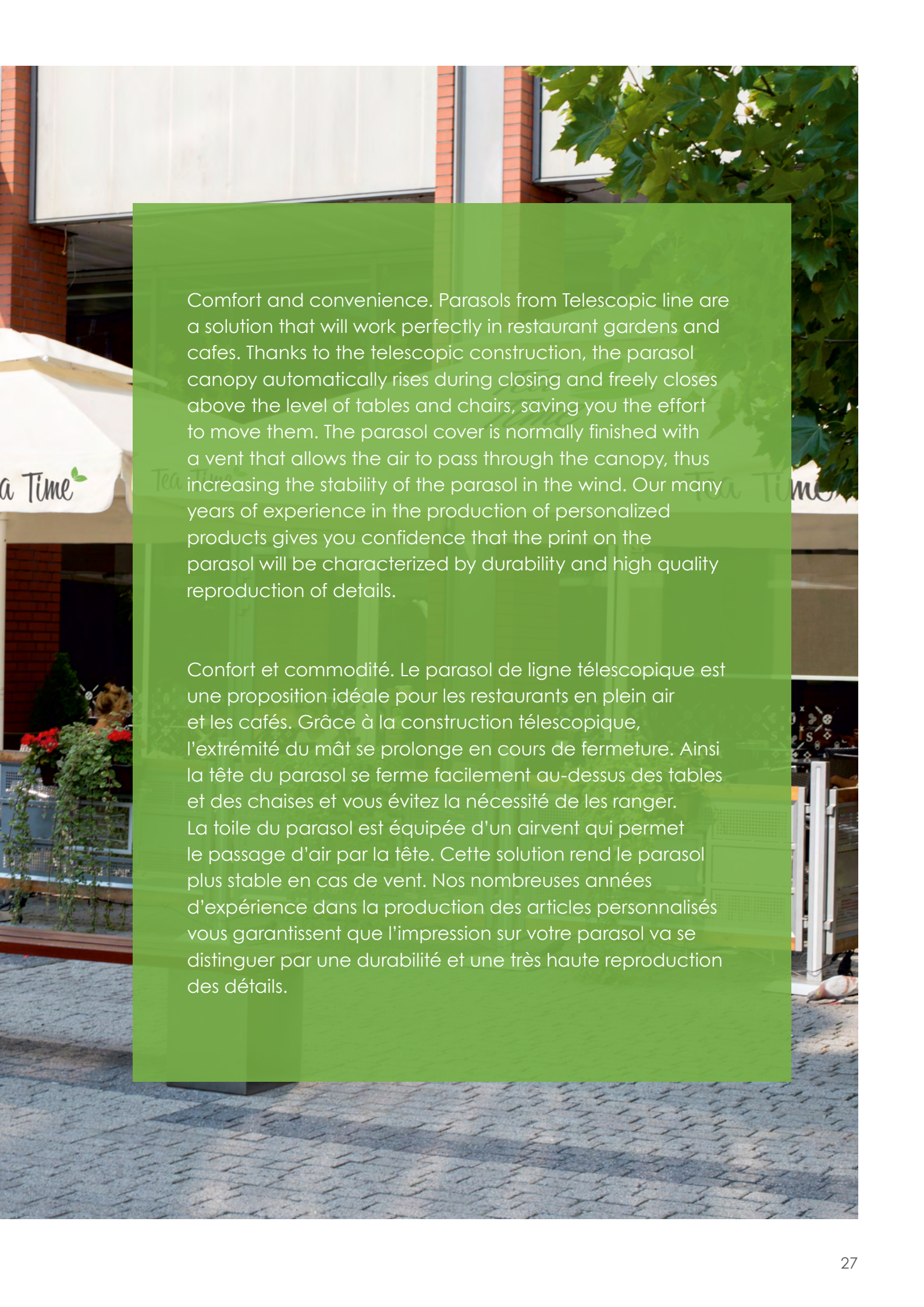

Comfort and convenience. Parasols from Telescopic line are a solution that will work perfectly in restaurant gardens and cafes. Thanks to the telescopic construction, the parasol canopy automatically rises during closing and freely closes above the level of tables and chairs, saving you the effort to move them. The parasol cover is normally finished with a vent that allows the air to pass through the canopy, thus increasing the stability of the parasol in the wind. Our many years of experience in the production of personalized products gives you confidence that the print on the parasol will be characterized by durability and high quality reproduction of details.

Confort et commodité. Le parasol de ligne télescopique est une proposition idéale pour les restaurants en plein air et les cafés. Grâce à la construction télescopique, l'extrémité du mât se prolonge en cours de fermeture. Ainsi la tête du parasol se ferme facilement au-dessus des tables et des chaises et vous évitez la nécessité de les ranger. La toile du parasol est équipée d'un airvent qui permet le passage d'air par la tête. Cette solution rend le parasol plus stable en cas de vent. Nos nombreuses années d'expérience dans la production des articles personnalisés vous garantissent que l'impression sur votre parasol va se distinguer par une durabilité et une très haute reproduction des détails.



Telescopic



Check out how to open this parasol
Voir comment ouvrir ce parasol



The used telescopic mechanism facilitates the daily use of the parasol.
Le mécanisme télescopique facilite l'utilisation quotidienne du parasol.

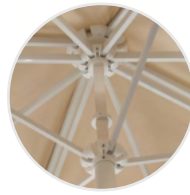

The structure of the parasol canopy remains strong, even in large sizes.
La structure de la tête du parasol reste solide, même dans les grandes tailles.

Easy to open and close the canopy even with its large surface.
Facile à ouvrir et à fermer la tête du parasol même avec sa grande surface.



Size Taille	3 x 3 m	3,5 x 3,5 m	4 x 4 m
Dimensions [mm]	A: 3000 B: 2870 C: 2090 D: 1170 E: 3380	A: 3500 B: 2940 C: 2075 D: 1030 E: 3660	A: 4000 B: 3110 C: 2020 D: 970 E: 3900

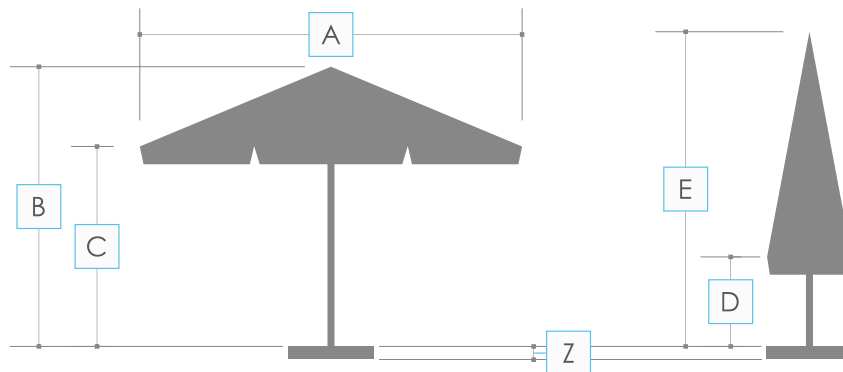

The Z value is the usable height of the base which, if used, must be added to the B and E values of the parasol. The value is available on pages 66-67.
La valeur Z est la hauteur utilisable de la base, qui, si elle est utilisée, doit être ajoutée aux valeurs B et E du parasol. Vous pouvez trouver la valeur aux pages 66-67.

Printing techniques / Technique d'impression



digital printing
impression numérique



flat printing
impression à plat



hand screen printing
impression en sérigraphie manuelle

Canopy finish / Finition de la tête du parasol



with valance
avec bas-volets



without valance
sans bas-volets



with vent
avec airvent



second roof
double toit

Type of fabric / Type de textile



woven fabric
toile tissée



woven fabric made of recycled yarn
(as an option)
tissu fabriqué à partir de fils recyclés
(en option)



Size Taille	3 x 3 m	3,5 x 3,5 m	4 x 4 m
Opening system Types de monture	telescopic-handle télescopique avec poignée		

	Canopy finish Finition de la tête du parasol		
Vent Airvent	as a standard en standard	as a standard en standard	as a standard en standard
Without vent Sans airvent	as option en option	-	-
Second roof Double toit	as option en option	as option en option	as option en option

Type and colour of frame Type et couleur de monture	aluminum, white en aluminium, blanche		
Number of ribs Nombre des baleines	8		
Type of base Types de pieds	PD600RS, PD600RSD, PDZ	PD700MR, PDZ	PDU-B40, PDZ
Permissible maximum wind speed Vitesse maximale admissible du vent	10,7 m/s (38 km/h)		
Pole diameter [mm] Diamètre du mât [mm]	60		

Optional / En option :

- + Mobile set for parasol bases
Système mobile pour les pieds
- + Protective cover
Housse de parasol
- + Rain gutters
Gouttières
- + Walls
Parois
- + Detachable wind valance for sunshade parasols
Bas-volets amovibles pour les parasols
- + Suspended advertising system for sunshade parasols
Système de publicité suspendu



12,5 m/s
45 km/h

Wine Story

Wine Story



Strong

A photograph of an outdoor cafe setting on a cobblestone street. In the foreground, there are tables and chairs, some with red umbrellas. In the background, there are multi-story buildings with red-tiled roofs and a weather vane on top. A large, semi-transparent orange rectangle is overlaid on the center of the image, containing text in English and French.

The Strong line was created for customers using parasols in particularly demanding weather conditions. This is one of our most durable parasols with reinforced, thicker mast and arm profiles. The parasol is provided with a telescopic opening system that lifts its canopy when closing.

As a standard the parasol is finished with a vent that allows free air circulation through the canopy. Additionally, we also offer the option of finishing the parasol with a second roof.

La ligne Strong a été créée pour les clients utilisant les parasols dans des conditions atmosphériques difficiles.

Ce parasol est un de nos modèles les plus résistants, avec le mât et les baleines renforcés et plus épais. Le tout est complété par un système d'ouverture télescopique qui soulève la tête du parasol pendant la fermeture.

En standard, la toile de parasol possède un airvent permettant le passage d'air. En option, nous proposons aussi le parasol avec double toit.



Strong



Check out how to open this parasol
Voir comment ouvrir ce parasol



High-strength frame,
tested in up to 45 km/h winds.
Le mât à haute résistance,
testé dans des vents de 45 km/h.



The opening mechanism in the form
of a handle with a telescopic system
improves opening.
Mécanisme d'ouverture sous la forme
d'une poignée avec un système
télescopique pour une ouverture facile.

A parasol with increased resistance to weather conditions,
thanks to its durable structure.

Parasol avec une résistance accrue aux intempéries, grâce
à sa structure durable.



Size Taille	3 x 3 m	3,5 x 3,5 m	4 x 4 m	5 x 5 m	5,5 m / 8
Dimensions [mm]	A: 3000 B: 2920 C: 2100 D: 1180 E: 3320 F: 1900 G: 820	A: 3500 B: 3260 C: 2180 D: 1070 E: 3600 F: 1910 G: 910	A: 4000 B: 3230 C: 2460 D: 1420 E: 4260 F: 1930 G: 1060	A: 5000 B: 3370 C: 2510 D: 1205 E: 4730 F: 2030 G: 815	A: 5500 B: 3300 C: 2270 D: 1530 E: 4320 F: 1940 G: 1090

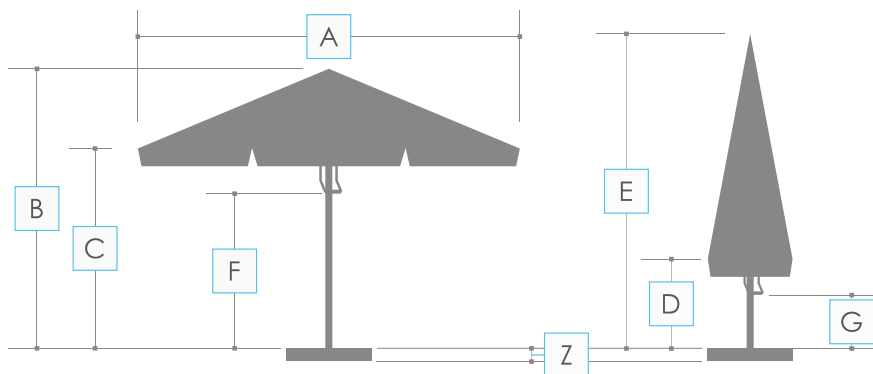

The Z value is the usable height of the base which, if used, must be added to the B and E values of the parasol. The value is available on pages 66-67.

La valeur Z est la hauteur utilisable de la base, qui, si elle est utilisée, doit être ajoutée aux valeurs B et E du parasol. Vous pouvez trouver la valeur aux pages 66-67.

Printing techniques / Technique d'impression



digital printing
impression numérique



flat printing
impression à plat



hand screen printing
impression en sérigraphie manuelle

Canopy finish / Finition de la tête du parasol



with valance
avec bas-volets



without valance
sans bas-volets



with vent
avec airvent



second roof
double toit

Type of fabric / Type de textile



woven fabric
toile tissée



woven fabric made of recycled yarn
(as an option)
tissu fabriqué à partir de fils recyclés
(en option)



Size Taille	3 x 3 m	3,5 x 3,5 m	4 x 4 m	5 x 5 m	5,5 m / 8
Opening system Types de monture	telescopic-handle télescopique avec poignée				

	Canopy finish Finition de la tête du parasol				
Vent Airvent	as a standard en standard				
Without vent Sans airvent	-				
Second roof Double toit	-		as option als Option		

Type and colour of frame Type et couleur de monture	aluminum frame, white or black monture en aluminium, blanche ou noire				
Number of ribs Nombre des baleines	8				
Type of base Types de pieds	PDUE-B50, PDZ	PDUE-B50, PDZ	PDUE-B50, PDZ	PK5-B50, PDZ5	PDUE-B50, PDZ
Permissible maximum wind speed Vitesse maximale admissible du vent	12,5 m/s (45 km/h)				
Pole diameter [mm] Diamètre du mât [mm]	75				

Optional / En option :

- + Protective cover
Housse de parasol
 - + Rain gutters
Gouttières
 - + Walls
Parois
 - + Lighting
Eclairage
 - + Heating
Chauffage
 - + Detachable wind valance for sunshade parasols
Bas-volets amovibles pour les parasols
- + Suspended advertising system for sunshade parasols
Système de publicité suspendu



12,5 m/s
45 km/h

Smith & Barkley

Smith & Barkley



Giant



Smith & Barkley

Giants among parasols. Giant line parasols guarantee eye-catching look and the possibility of shading a very large area using one parasol. It's ideal solution for hotels and big restaurants. The reinforced, twelve-arm structure of the frame guarantee safety and stability. The practical telescopic opening system is operated with a crank. The canopy of each Giant parasol is finished with a second roof that ensures optimal air circulation.

Géants parmi les parasols. Les parasols Giant vont sûrement attirer l'attention de vos clients. De plus, ils vous donnent la possibilité d'ombrager une très grande surface à l'aide d'un seul parasol. C'est une proposition idéale pour les hôtels et les restaurants en plein air. La structure renforcée avec douze baleines garantit la sécurité et la stabilité. Le parasol est équipé d'un système d'ouverture télescopique par manivelle. La tête de chaque parasol Giant possède un double toit qui assure une circulation d'air optimale.



Giant



Check out how to open this parasol
Voir comment ouvrir ce parasol

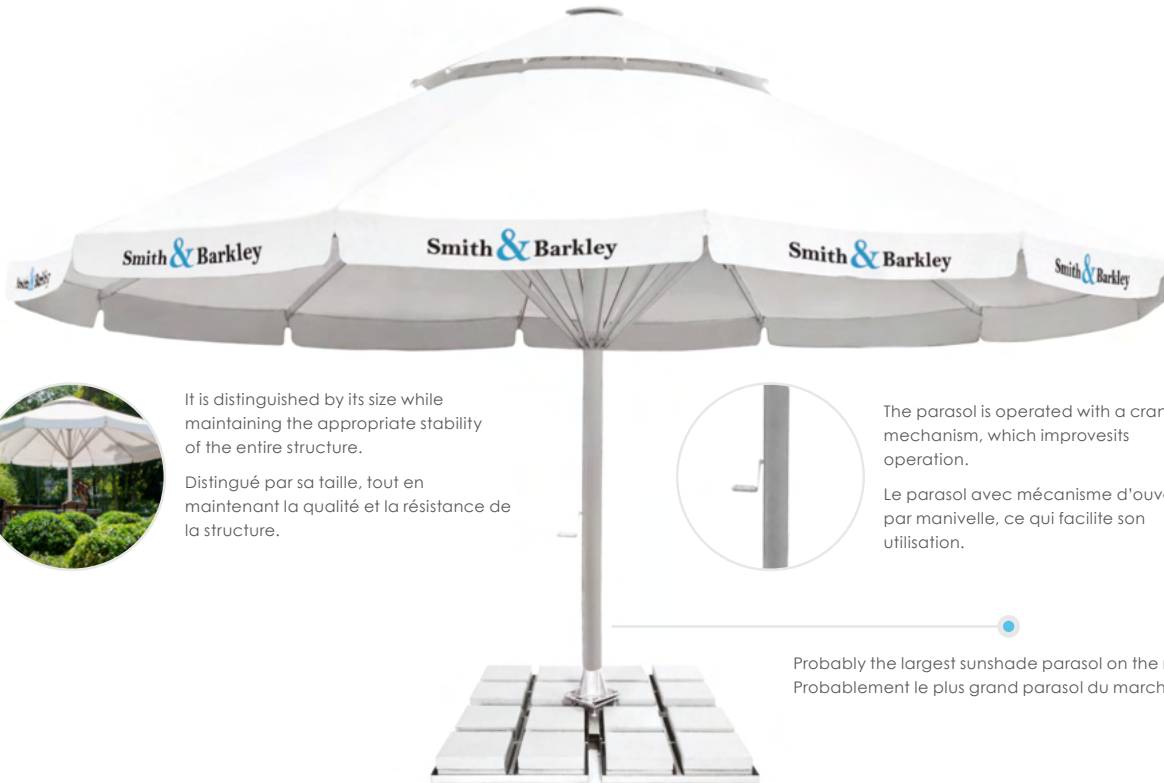

It is distinguished by its size while maintaining the appropriate stability of the entire structure.

Distingué par sa taille, tout en maintenant la qualité et la résistance de la structure.



The parasol is operated with a crank mechanism, which improves its operation.

Le parasol avec mécanisme d'ouverture par manivelle, ce qui facilite son utilisation.

Probably the largest sunshade parasol on the market.
Probablement le plus grand parasol du marché.



Size Taille	6 x 6 m	7 x 7 m	8 m / 12
Dimensions [mm]	A: 6000 B: 4100 C: 2750 D: 1470 E: 6000	A: 7000 B: 4100 C: 2300 D: 680 E: 5950	A: 8000 B: 4200 C: 2550 D: 1530 E: 5900

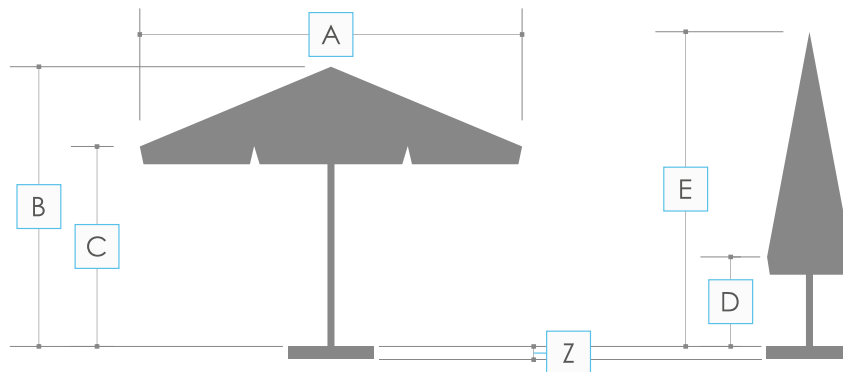

The Z value is the usable height of the base which, if used, must be added to the B and E values of the parasol. The value is available on pages 66-67.

La valeur Z est la hauteur utilisable de la base, qui, si elle est utilisée, doit être ajoutée aux valeurs B et E du parasol. Vous pouvez trouver la valeur aux pages 66-67.

Printing techniques / Technique d'impression



hand screen printing
impression en sérigraphie manuelle

Canopy finish / Finition de la tête du parasol



with valance
avec bas-volets



without valance
sans bas-volets



second roof
double toit

Type of fabric / Type de textile



woven fabric
toile tissée



Size Taille	6 x 6 m	7 x 7 m	8 m / 12
Opening system Types de monture	crank manivelle		

	Canopy finish Finition de la tête du parasol		
Vent Airvent	-		
Without vent Sans airvent	-		
Second roof Double toit	as a standard en standard		

Type and colour of frame Type et couleur de monture	aluminum, white en aluminium, blanche		
Number of ribs Nombre des baleines	12		
Type of base Types de pieds	PDK7-B40, PDZ7		
Permissible maximum wind speed Vitesse maximale admissible du vent	12,5 m/s (45 km/h)		
Pole diameter [mm] Diamètre du mât [mm]	140		

Optional / En option :

- + Protective cover
Housse de parasol
- + Lighting
Eclairage



Rectangular

YOURGARDEN YOURGARDEN YOURGARDEN



7,9 m/s
28 km/h



Perfectly matched. Rectangular parasols are an original way to promote your brand. Rectangular shape allows optimal use of narrow spaces. The telescopic opening system lifts the canopy of the parasol when closing so that the parasol can be freely closed above the tables and chairs.

As standard, the canopy is finished with vent that allows free air circulation. In addition, you can combine many parasols into one roof using special gutters.

Idéalement adapté. Les parasols rectangulaires sont un moyen original pour promouvoir votre marque. La forme rectangulaire permet d'aménager de façon optimale des espaces étroits. Grâce à la construction télescopique, l'extrémité du mât se prolonge en cours de la fermeture. Ainsi la tête du parasol se ferme au-dessus des tables et des chaises. En standard, la toile du parasol est équipée d'un airvent qui permet à l'air de circuler librement. De plus, vous pouvez raccorder ces parasols ensemble à l'aide des gouttières et créer un grand système d'ombrage.



Rectangular



Check out how to open this parasol
Voir comment ouvrir ce parasol

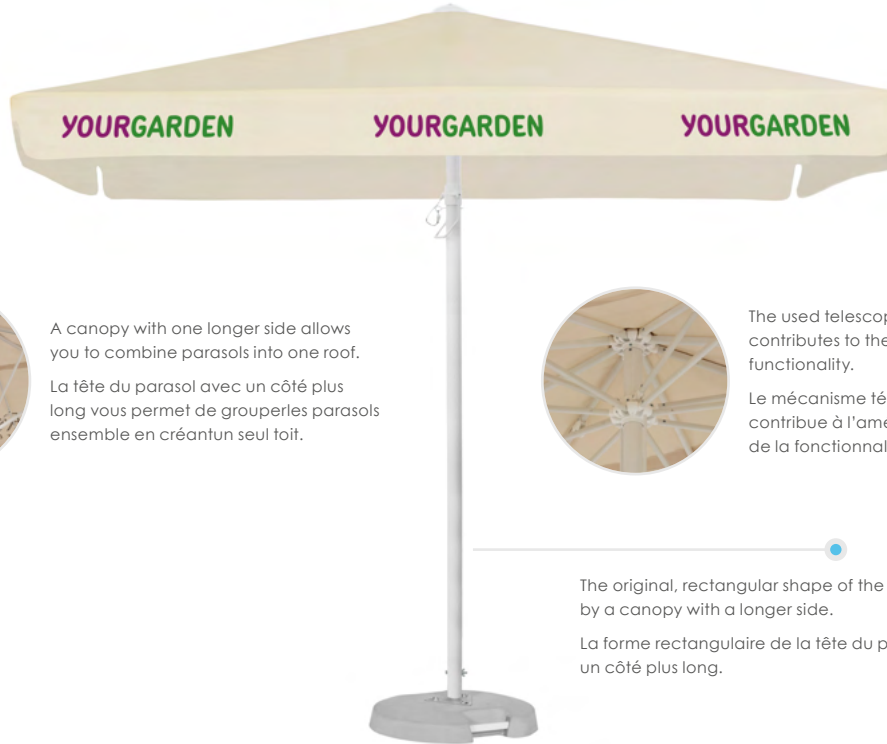

A canopy with one longer side allows you to combine parasols into one roof.

La tête du parasol avec un côté plus long vous permet de grouper les parasols ensemble en créant un seul toit.



The used telescopic mechanism contributes to the improvement of its functionality.

Le mécanisme télescopique utilisé contribue à l'amélioration de la fonctionnalité.

The original, rectangular shape of the parasol, distinguishable by a canopy with a longer side.

La forme rectangulaire de la tête du parasol distinguable avec un côté plus long.



Size Taille	2 x 3 m	3 x 4 m
Dimensions [mm]	A₁ : 2000 A₂ : 3000 B : 2870 C : 2370 D : 1340 E : 3220	A₁ : 3000 A₂ : 4000 B : 2960 C : 2370 D : 1000 E : 3530

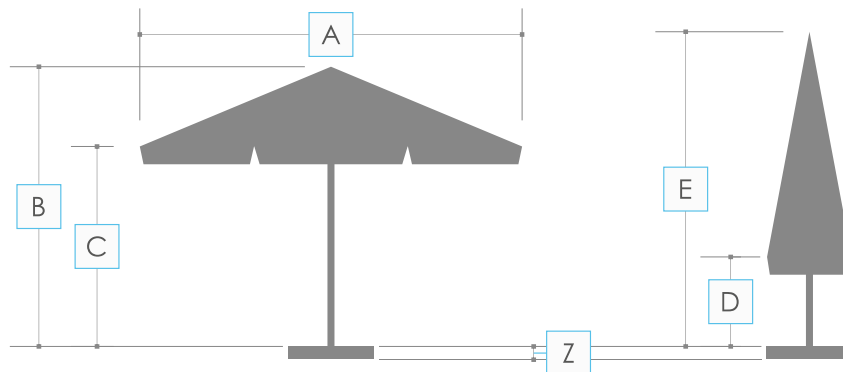

The Z value is the usable height of the base which, if used, must be added to the B and E values of the parasol. The value is available on pages 66-67.

La valeur Z est la hauteur utilisable de la base, qui, si elle est utilisée, doit être ajoutée aux valeurs B et E du parasol. Vous pouvez trouver la valeur aux pages 66-67.

Printing techniques / Technique d'impression



digital printing
impression numérique

UV 5



flat printing
impression à plat

UV 7



hand screen printing
impression en sérigraphie manuelle

UV 7

Canopy finish / Finition de la tête du parasol



with valance
avec bas-volets



without valance
sans bas-volets



with vent
avec airvent

Type of fabric / Type de textile



woven fabric
toile tissée



woven fabric made of recycled yarn
(as an option)
tissu fabriqué à partir de fils recyclés
(en option)

rPET



Size Taille	2 x 3 m	3 x 4 m
Opening system Types de monture	telescopic-handle télescopique avec poignée	

	Canopy finish Finition de la tête du parasol	
Vent Airvent	-	as a standard en standard
Without vent Sans airvent	as a standard en standard	as option en option
Second roof Double toit	-	

Type and colour of frame Type et couleur de monture	aluminum, white en aluminium, blanche	
Number of ribs Nombre des baleines	6	8
Type of base Types de pieds	PD600RS, PD600RSD, PDZ	PD700MR, PDZ
Permissible maximum wind speed Vitesse maximale admissible du vent	7,9 m/s (28 km/h)	
Pole diameter [mm] Diamètre du mât [mm]	60	

Optional / En option :

+ Mobile set for parasol bases
Système mobile pour les pieds

+ Protective cover
Housse de parasol

+ Rain gutters
Gouttières

+ Lighting
Eclairage



7,9 m/s
28 km/h

Restaurant & Cafe *Café Art*



Side Leg Rio



Stand out with modernity. Parasols with side leg Rio and Ibiza are the perfect, eye-catching advertising medium for exclusive brands, hotels and restaurants. The lateral position of the leg allows full use of the shaded area under the canopy, does not interfere with visibility and does not restrict placement of the furniture under the canopy. Parasols have adjustable angle of the canopy, so you can better match them to the solar conditions. Additionally parasols can be equipped with a mosquito net, which will be great for summer evenings.

Design moderne. Les parasols déportés Rio et Ibiza sont des supports de publicité qui attirent l'attention des clients. Ils sont parfaits pour les marques exclusives, les hôtels et les restaurants. Le mât latéral permet d'aménager pleinement la surface ombragée et ne perturbe pas la visibilité. L'angle d'inclinaison de la toile est réglable ce qui permet de l'orienter en fonction de la position du soleil. Ces parasols peuvent également être équipés d'une moustiquaire qui sera idéale pour les soirées d'été.



Side Leg Rio



Check out how to open this parasol
Voir comment ouvrir ce parasol



The side pole, with the possibility of rotation, allows you to freely arrange the space under the parasol.

Le mât déporté, avec possibilité de rotation, permet d'aménager librement l'espace sous le parasol.



Ergonomic handle with the function of closing and opening also allows adjusting the angle of inclination.

Poignée ergonomique avec fonction de fermeture, d'ouverture et de réglage de l'angle d'inclinaison.

The position of the parasol canopy and the angle of its inclination can be adjusted.
La position de la tête du parasol et l'angle de son inclinaison peuvent être ajustés.



Size Taille	3 x 3 m
Dimensions [mm]	A: 3315 B: 2605 C₁: 2040 C₂: 2140 D: 500 E: 2605 F: 3000

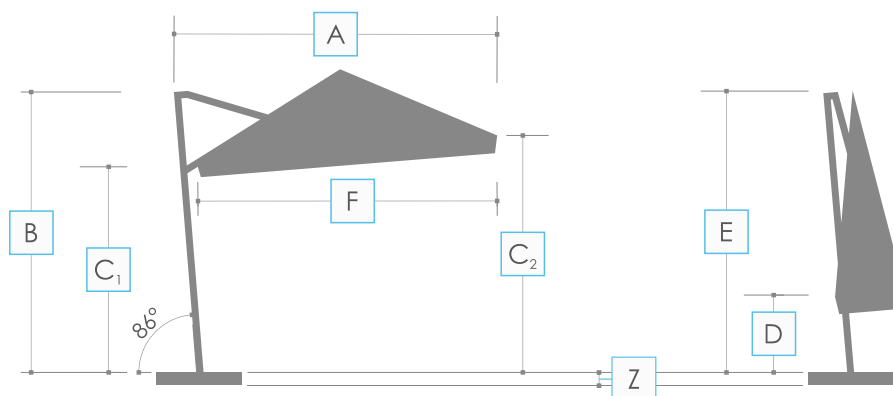

The Z value is the usable height of the base which, if used, must be added to the B and E values of the parasol. The value is available on pages 66-67.
La valeur Z est la hauteur utilisable de la base, qui, si elle est utilisée, doit être ajoutée aux valeurs B et E du parasol. Vous pouvez trouver la valeur aux pages 66-67.

Printing techniques / Technique d'impression



digital printing
impression numérique



flat printing
impression à plat



hand screen printing
impression en sérigraphie manuelle

Canopy finish / Finition de la tête du parasol



with valance
avec bas-volets



without valance
sans bas-volets



with vent
avec airvent

Type of fabric / Type de textile



woven fabric
toile tissée



woven fabric made of recycled yarn
(as an option)
tissu fabriqué à partir de fils recyclés
(en option)



Size Taille	3 x 3 m
Opening system Types de monture	crank and handle manivelle et poignée
Canopy finish Finition de la tête du parasol	
Vent Airvent	as a standard en standard
Without vent Sans airvent	-
Second roof Double toit	-
Type and colour of frame Type et couleur de monture	aluminum, grey RAL 9022 en aluminium, gris RAL 9022
Number of ribs Nombre des baleines	8
Type of base Types de pieds	PDUE-B50 RIO
Permissible maximum wind speed Vitesse maximale admissible du vent	7,9 m/s (28 km/h)
Pole diameter [mm] Diamètre du mât [mm]	60 x 60

Optional / En option :

+ Protective cover
Housse de parasol

+ Mosquito net
Moustiquaire



7,9 m/s
28 km/h



Side Leg Ibiza



Stand out with modernity. Parasols with side leg Rio and Ibiza are the perfect, eye-catching advertising medium for exclusive brands, hotels and restaurants. The lateral position of the leg allows full use of the shaded area under the canopy, does not interfere with visibility and does not restrict placement of the furniture under the canopy. Parasols have adjustable angle of the canopy, so you can better match them to the solar conditions. Additionally parasols can be equipped with a mosquito net, which will be great for summer evenings.

Design moderne. Les parasols déportés Rio et Ibiza sont des supports de publicité qui attirent l'attention des clients. Ils sont parfaits pour les marques exclusives, les hôtels et les restaurants. Le mât latéral permet d'aménager pleinement la surface ombragée et ne perturbe pas la visibilité. L'angle d'inclinaison de la toile est réglable ce qui permet de l'orienter en fonction de la position du soleil. Ces parasols peuvent également être équipés d'une moustiquaire qui sera idéale pour les soirées d'été.



Side Leg Ibiza



Check out how to open this parasol
Voir comment ouvrir ce parasol



Double side pole with adjustable angle of the canopy.

Mât déporté double avec angle d'inclinaison de la tête réglable.

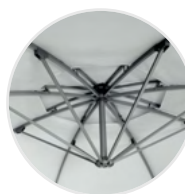

The modern design of the parasols distinguished by the quality of workmanship and functionality.

Le design moderne du parasol se distingue par la qualité de fabrication et la fonctionnalité.

A parasol with a double side pole for optimal use of the area under the canopy.
Parasol avec mât déporté pour une utilisation optimale de la zone sous parasol.



Size Taille	3,5 x 3,5 m	3,5 m / 8	4,2 m / 8
Dimensions [mm]	A: 3500 B: 3165 C: 1905 D: 180 E: 2780 F: 4030 G: 1545	A: 3500 B: 2945 C: 2035 D: 500 E: 2600 F: 4050 G: 1615	A: 4200 B: 3280 C: 2150 D: 590 E: 3030 F: 4600 G: 1660

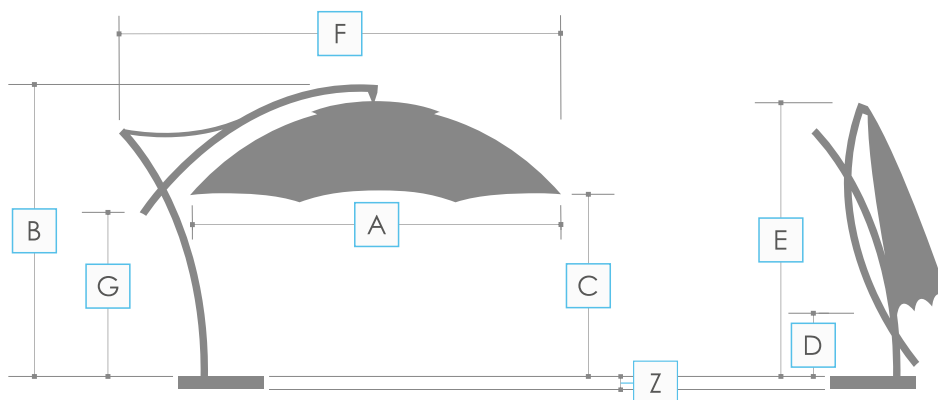

The Z value is the usable height of the base which, if used, must be added to the B and E values of the parasol. The value is available on pages 66-67.
La valeur Z est la hauteur utilisable de la base, qui, si elle est utilisée, doit être ajoutée aux valeurs B et E du parasol. Vous pouvez trouver la valeur aux pages 66-67.

Printing techniques / Technique d'impression



digital printing
impression numérique



flat printing
impression à plat



hand screen printing
impression en sérigraphie manuelle

Canopy finish / Finition de la tête du parasol



without valance
sans bas-volets



with vent
avec airvent



second roof
double toit

Type of fabric / Type de textile



woven fabric
toile tissée



woven fabric made of recycled yarn
(as an option)
tissu fabriqué à partir de fils recyclés
(en option)



Size Taille	3,5 x 3,5 m	3,5 m / 8	4,2 m / 8
Opening system Types de monture	crank and handle manivelle et poignée		

	Canopy finish Finition de la tête du parasol		
Vent Airvent	as a standard en standard	-	-
Without vent Sans airvent	-		
Second roof Double toit	-	as a standard en standard	as a standard en standard

Type and colour of frame Type et couleur de monture	aluminum, grey RAL 9022 en aluminium, gris RAL 9022		
Number of ribs Nombre des baleines	8		
Type of base Types de pieds	PDKI-BCW		
Permissible maximum wind speed Vitesse maximale admissible du vent	7,9 m/s (28 km/h)		
Pole diameter [mm] Diamètre du mât [mm]	70		

Optional / En option :

+ Protective cover
Housse de parasol

+ Lighting
Eclairage

+ Mosquito net
Moustiquaire



Atlantic



Safe and solid
Sécurité et fiabilité



Atlantic parasol was designed by Litex Promo to meet the expectation of the most demanding customers, not satisfied with ordinary, classic advertising parasols. Taking into account the exceptional design of Atlantic parasol, the use of this product is especially effective for demanding customers who wish to associate their brand with premium shelf products and services on the highest level. Do you need more information? Ask for a dedicated product catalogue.

Le parasol Atlantic a été conçu par Litex Promo pour répondre aux attentes des clients les plus exigeants, non satisfaits des parasols publicitaires ordinaires et classiques. Compte tenu du design exceptionnel du parasol Atlantic, l'utilisation de ce produit est particulièrement efficace pour les clients exigeants qui souhaitent associer leur marque à des produits et services haut de gamme au plus haut niveau. Avez-vous besoin de plus amples informations ? Demandez un catalogue de produits dédié.



19,4 m/s
69,8 km/h



Atlantic



Check out how to open this parasol
Voir comment ouvrir ce parasol



Telescopic sheathing stretching system.
Système de tension de toile télescopique.

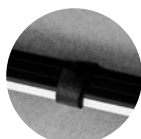

Additional Velcro strapping.
Fixation à bande velcro supplémentaire.



Stable aluminium hinge.
Charnière stable en aluminium.

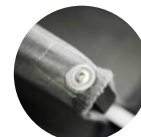

Telescopic sheathing stretching system.
Système de montage assurant la stabilité de toile.



Without illumination.
Sans éclairage.



Illumination on arms and supports.
Éclairage sur les baleines et les contre-baleines.

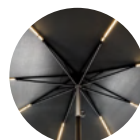

Illumination on arms.
Éclairage sur les baleines.

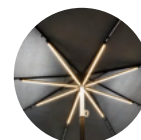

Illumination on supports.
Éclairage sur les contre-baleines.



Size Taille	4 m / 8	5 m / 8	3 × 4 m	4 × 5 m	3 × 3 m	3,5 × 3,5 m	4 × 4 m	5 × 5 m
Dimensions [mm]	A: 4000 B: 3200 C: 2200 D: 1900 E: 3450 F: 1200 G: 590	A: 5000 B: 3350 C: 2200 D: 2000 E: 3750 F: 1000 G: 520	A ₁ : 3000 A ₂ : 4000 B: 2900 C: 2200 D: 1990 E: 3450 F: 900 G: 420	A ₁ : 4000 A ₂ : 5000 B: 3050 C: 2200 D: 2100 E: 3920 F: 700 G: 370	A: 3000 B: 3000 C: 2200 D: 2000 E: 3350 F: 1170 G: 420	A: 3500 B: 3000 C: 2200 D: 1850 E: 3500 F: 900 G: 380	A: 4000 B: 3100 C: 2200 D: 1850 E: 3700 F: 800 G: 430	A: 5000 B: 3350 C: 2200 D: 2020 E: 4250 F: 670 G: 610

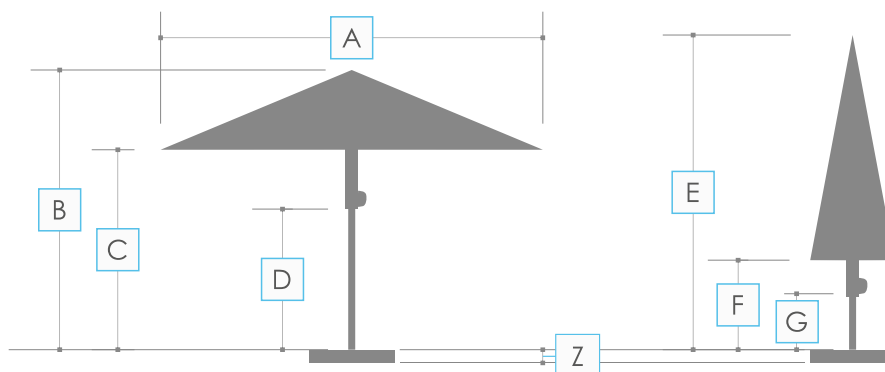

The Z value is the usable height of the base which, if used, must be added to the B and E values of the parasol. The value is available on pages 66-67.
La valeur Z est la hauteur utilisable de la base, qui, si elle est utilisée, doit être ajoutée aux valeurs B et E du parasol. Vous pouvez trouver la valeur aux pages 66-67.

Printing techniques / Technique d'impression



hand screen printing
impression en sérigraphie manuelle

Canopy finish / Finition de la tête du parasol



with valance
avec bas-volets



without valance
sans bas-volets

Type of fabric / Type de textile



woven fabric
toile tissée



Size Taille	4 m / 8	5 m / 8	3 x 4 m	4 x 5 m	3 x 3 m	3,5 x 3,5 m	4 x 4 m	5 x 5 m
Opening system Types de monture	telescopic télescopique							

	Canopy finish Finition de la tête du parasol							
Vent Airvent	-							
Without vent Sans airvent	as a standard en standard							
Second roof Double toit	-							

Type and colour of frame Type et couleur de monture	anodized aluminum, black (C-35) en aluminium anodisé, noir (C-35)							
Number of ribs Nombre des baleines	8							
Type of base Types de pieds	PDK 50 ATLANTIC, PDZ ATLANTIC							
Permissible maximum wind speed Vitesse maximale admissible du vent	19,4 m/s (69,8 km/h)							
Pole diameter [mm] Diamètre du mât [mm]	80 x 4							

Optional / En option :

- + Rain gutters
Gouttières
- + Lighting
Éclairage
- + Detachable wind valance for sunshade parasols
Bas-volets amovibles pour les parasols



10.7 m/s
38 km/h

Smith & Barkley



Easy Up / Telescopic
Easy To Transport



The line of parasols with the Easy To Transport function is the new structure, based on a two-piece mast, is resistant to gusts of wind, just like a standard parasol. We focus on versatility – the covers used for Easy To Transport parasols will also fit standard frames in a given size and line. Thanks to the possibility of detaching the lower part of the pole, even large four-meter parasols become much simpler and more convenient to store, taking up less space than its classic counterparts. The parasols are easy to use and folding them is quick.

Notre nouveau parasol télescopique avec la fonction Easy To Transport se distingue par la longueur de l'emballage plus courte de 1,5 m. La nouvelle structure, basée sur un mât en deux parties, résiste aux rafales de vent, tout comme un parasol télescopique standard. Nous nous concentrons sur la polyvalence - les housses utilisées pour les parasols Easy To Transport s'adapteront également aux parasols standard. Grâce à la possibilité de détacher la partie inférieure du mât, même les grands parasols de quatre mètres deviennent beaucoup plus faciles et plus pratiques à ranger, prenant moins de place que leurs homologues classiques. Les parasols sont faciles à utiliser et le pliage est également facile.



Easy Up

Easy To Transport



Check out how to open this parasol
Voir comment ouvrir ce parasol



Convenient and intuitive system of opening with a safe handle.
Système d'ouverture pratique et intuitif avec poignée.



Two-part mast for economical transport.
Mât en deux parties pour un transport économique.

Despite the use of a two-piece mast, Easy To Transport parasols are as strong as their classic counterparts with a one-piece mast.
Bien qu'ils possèdent le mât en deux parties, nos parasols Easy To Transport sont aussi durables que leurs versions classiques avec mât en une partie.



Size Taille	3 m / 8	4 m / 8
Dimensions [mm]	A: 3000 B: 2620 C: 2100 D: 1070 E: 2620 F: 1870 G: 970 H: 1720 I: 1000	A: 4000 B: 2820 C: 2100 D: 780 E: 2820 F: 1900 G: 610 H: 2250 I: 650

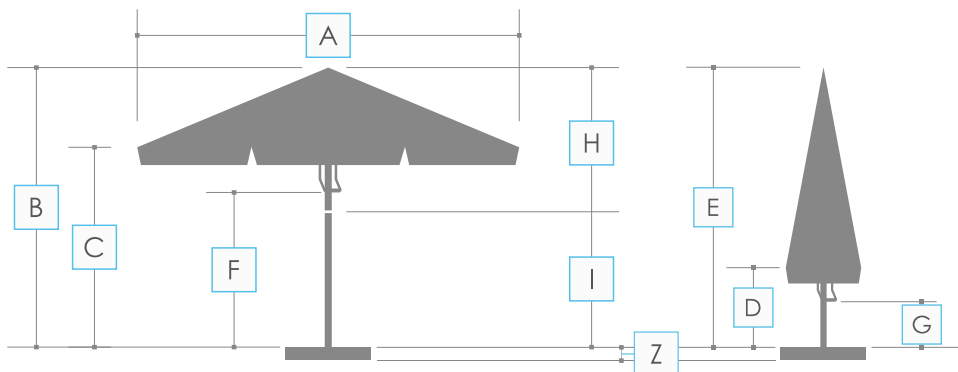

The Z value is the usable height of the base which, if used, must be added to the B and E values of the parasol. The value is available on pages 66-67.
La valeur Z est la hauteur utilisable de la base, qui, si elle est utilisée, doit être ajoutée aux valeurs B et E du parasol. Vous pouvez trouver la valeur aux pages 66-67.

Printing techniques / Technique d'impression



digital printing
impression numérique



flat printing
impression à plat



hand screen printing
impression en sérigraphie manuelle

Canopy finish / Finition de la tête du parasol



with valance
avec bas-volets



without valance
sans bas-volets



with vent
avec airvent

Type of fabric / Type de textile



woven fabric
toile tissée



woven fabric made of recycled yarn
(as an option)
tissu fabriqué à partir de fils recyclés
(en option)



Size Taille	3 m / 8	4 m / 8
Opening system Types de monture	easyshift with lock poignée avec loquet	

	Canopy finish Finition de la tête du parasol
Vent Airvent	as option en option
Without vent Sans airvent	as a standard en standard
Second roof Double toit	-

Type and colour of frame Type et couleur de monture	aluminum frame; standard colour - white, black colour - as option monture en aluminium ; couleur blanche en standard, couleur noire en option	
Number of ribs Nombre des baleines	8	
Type of base Types de pieds	PD600RS, PD600RSD, PDZ	PD700MR, PDZ
Net weight [kg] Poids net [kg]	9,6	12,4
Gross weight [kg] Poids brut [kg]	11,5	14,5
Package size [mm] Dimensions du colis [mm]	240 x 240 x 1900	240 x 240 x 2250
Permissible maximum wind speed Vitesse maximale admissible du vent	10,7 m/s (38 km/h)	
Pole diameter [mm] Diamètre du mât [mm]	60	

Optional / En option :

+ Protective cover
Housse de parasol

+ Mobile set for parasol bases
Système mobile pour les pieds



Telescopic

Easy To Transport



Check out how to open this parasol
Voir comment ouvrir ce parasol

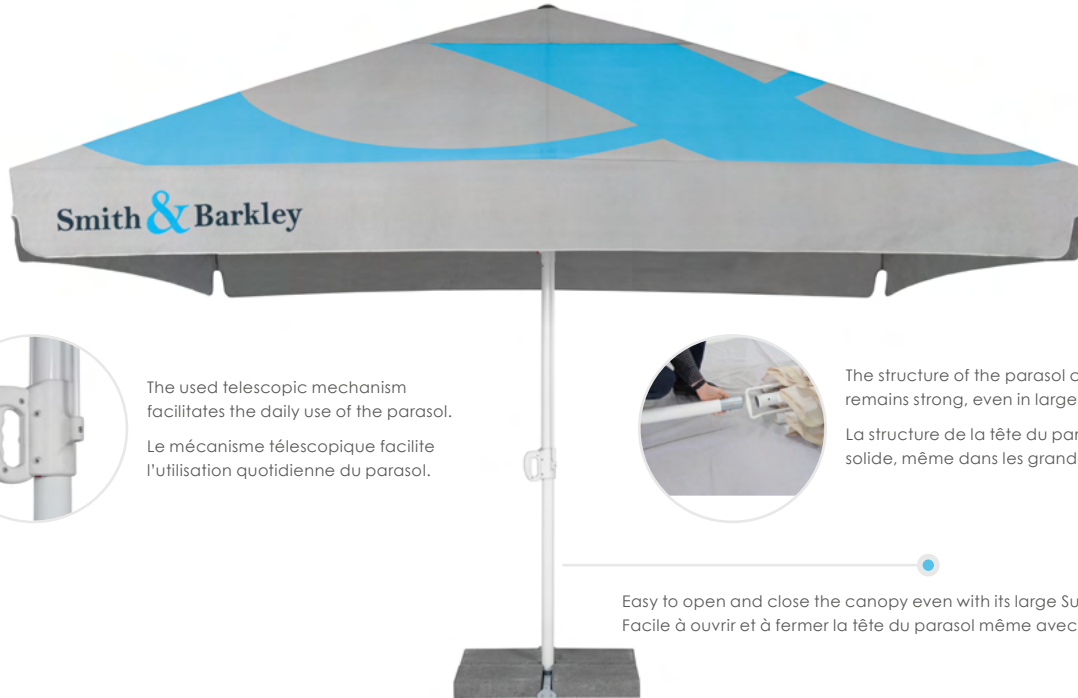

The used telescopic mechanism facilitates the daily use of the parasol.

Le mécanisme télescopique facilite l'utilisation quotidienne du parasol.



The structure of the parasol canopy remains strong, even in large sizes.

La structure de la tête du parasol reste solide, même dans les grandes tailles.

Easy to open and close the canopy even with its large surface.
Facile à ouvrir et à fermer la tête du parasol même avec sa grande surface.



Size Taille	3 x 3 m	4 x 4 m
Dimensions [mm]	A: 3000 B: 3000 C: 2200 D: 1650 E: 3900 F: 900 G: 1850 H: 2050	A: 4000 B: 3200 C: 2200 D: 1150 E: 4100 F: 900 G: 1850 H: 2050

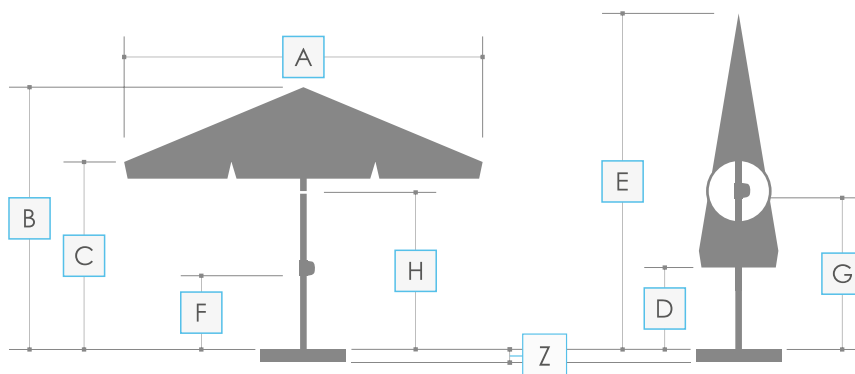

The Z value is the usable height of the base which, if used, must be added to the B and E values of the parasol. The value is available on pages 66-67.
La valeur Z est la hauteur utilisable de la base, qui, si elle est utilisée, doit être ajoutée aux valeurs B et E du parasol. Vous pouvez trouver la valeur aux pages 66-67.

Printing techniques / Technique d'impression



digital printing
impression numérique



flat printing
impression à plat



hand screen printing
impression en sérigraphie manuelle

Canopy finish / Finition de la tête du parasol



with valance
avec bas-volets



without valance
sans bas-volets



with vent
avec airvent

Type of fabric / Type de textile



woven fabric
toile tissée



woven fabric made of recycled yarn
(as an option)
tissu fabriqué à partir de fils recyclés
(en option)



Size Taille	3 x 3 m	4 x 4 m
Opening system Types de monture	telescopic-handle télescopique avec poignée	

	Canopy finish Finition de la tête du parasol	
Vent Airvent	as a standard en standard	
Without vent Sans airvent	as option en option	
Second roof Double toit	-	

Type and colour of frame Type et couleur de monture	aluminum frame; standard colour - white, black colour - as option monture en aluminium ; couleur blanche en standard, couleur noire en option	
Number of ribs Nombre des baleines	8	
Type of base Types de pieds	PD600RS, PD600RSD, PDZ	PDU-B40, PDZ
Net weight [kg] Poids net [kg]	17,2	29,1
Gross weight [kg] Poids brut [kg]	19,7	31,6
Package size [mm] Dimensions du colis [mm]	250 x 250 x 2370	
Permissible maximum wind speed Vitesse maximale admissible du vent	10,7 m/s (38 km/h)	
Pole diameter [mm] Diamètre du mât [mm]	60	

Optional / En option :

+ Protective cover
Housse de parasol

+ Mobile set for parasol bases
Système mobile pour les pieds



Harmony ECOWAY

skin & health
NATURAL CARE



7,9 m/s
28 km/h



The Harmony parasol has been designed in a way so as to minimise its environmental impact. We use less plastic and focus on using recycled materials and biodegradable plastics instead. We took care to ensure that the foil used for packing the parasol or the cardboard box used for transportation were also 100% eco-friendly. This is our contribution to reducing waste and protecting our planet.

Le parasol Harmony a été conçu pour minimiser l'impact négatif sur l'environnement. Nous utilisons moins de plastique et nous choisissons des matériaux recyclés et biodégradables. Nous avons veillé à ce que le film dans lequel le parasol est emballé et la boîte en carton pour le transport soient également 100 % écologiques. C'est notre contribution à la réduction des déchets et à la protection de notre planète.



Harmony ECOWAY



Canopy made from recycled fabric (rPET).

Toile en tissu recyclé (rPET)



Recycled aluminium frame, recyclable.

Monture en aluminium recyclé, avec possibilité de la recycler à nouveau.

Modern design and perfect size for small spaces.
Design moderne et taille idéale pour les petits espaces.



Size Taille	2 x 2 m
Dimensions [mm]	A: 2000 B: 2350 C: 2055 D: 940 E: 2350 F: 700

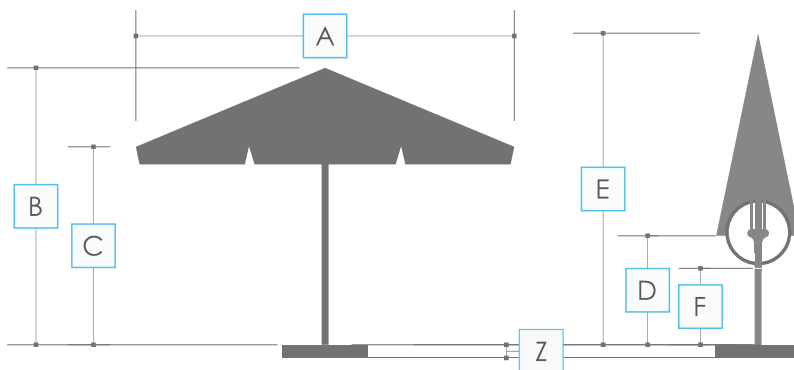

The Z value is the usable height of the base which, if used, must be added to the B and E values of the parasol. The value is available on pages 66-67.
La valeur Z est la hauteur utilisable de la base, qui, si elle est utilisée, doit être ajoutée aux valeurs B et E du parasol. Vous pouvez trouver la valeur aux pages 66-67.

Printing techniques / Technique d'impression



digital printing
impression numérique



flat printing
impression à plat

Canopy finish / Finition de la tête du parasol



with valance
avec bas-volets



without valance
sans bas-volets



with vent
avec airvent

Type of fabric / Type de textile



woven fabric made of recycled yarn
tissu fabriqué à partir de fils recyclés



Size Taille	2 x 2 m
Opening system Types de monture	skip le système Pousser / Tirer

	Canopy finish Finition de la tête du parasol
Vent Airvent	as a standard en standard
Without vent Sans airvent	-
Second roof Double toit	-

Type and colour of frame Type et couleur de monture	aluminum + steel, anthracite RAL 7021, mat aluminium + acier, anthracite RAL 7021, mat
Number of ribs Nombre des baleines	4
Type of base Types de pieds	PB450R40
Permissible maximum wind speed Vitesse maximale admissible du vent	7,9 m/s (28 km/h)
Pole diameter [mm] Diamètre du mât [mm]	40

Optional / En option :

- + Protective cover
Housse de protection
- + Steel base cover
Un cache-pied en acier
- + Laminated sticker with any print on the base
Un autocollant laminé personnalisé sur la base
- + Engraving on the frame
Gravure sur la monture



Bases / Pieds



BKR



ADRIATIC



PD450M

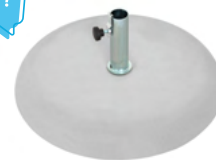

PD510



PD700MR



PD550RS*



PD600RS*



PD600RSD*



PD580RS*



Mobile set /
Set mobile
(PD550RS / PD600RS / PD580RS)



PD800RS



Mobile set /
Set mobile



PB450R40



PB370R15

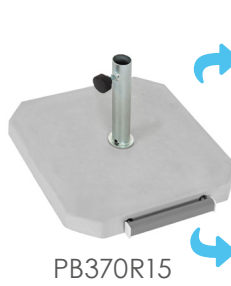

PB370R25



PDU



PDU-B40



PDUE



PDUE-B50

*The colour of the handles may differ depending on the production lot.

*La couleur des poignées peut varier d'un lot de fabrication à l'autre



Bases / Pieds



PDK5

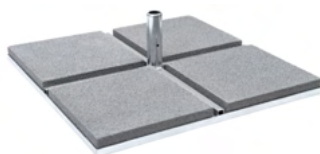

PDK5-B50



PDK7

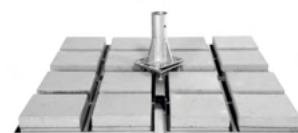

PDUE GIANT



PDUE RIO



PDUE RIO + rotator

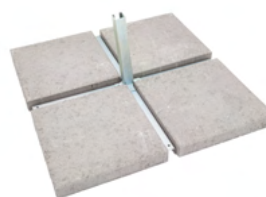

PDUE-B50 RIO

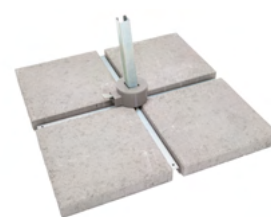

PDUE-B50 RIO + rotator



PDKI



PDKI-BCW

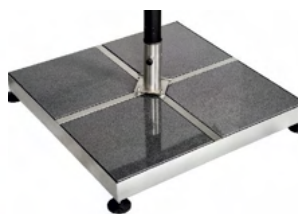

PDK 50 ATLANTIC



PDP 50 ATLANTIC
BLACK

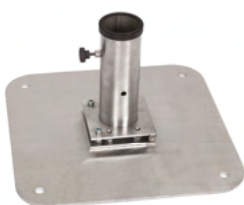

PDP 50 ATLANTIC
SILVER



PDZ ATLANTIC

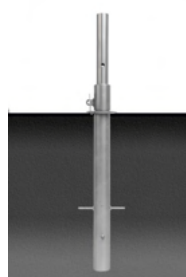

PDZ

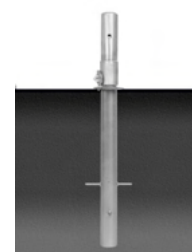

PDZ5

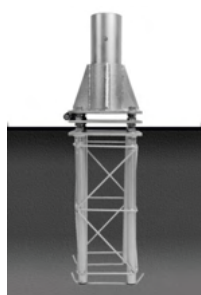

PDZ7

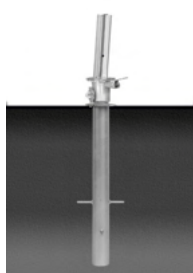

PDZ RIO



PDZI



Bases Pieds

	Beach Parasol						Eco Line		Easy Up						Classic				Telescopic	
	□	□	□	□	○	○	○	○	□	□	□	○	○	○	□	□	□	○	□	□
	1.25 m	1.35 m	1.8 m	2 m	1.8 m	2 m	2 m	2.5 m	2 m	2.5 m	3 m	3 m	3.5 m	4 m	3 m	3.5 m	4 m	4 m	3 m	3.5 m
BKR: 12 l, Z: 100 mm	•	•	•		•	•														
Adriatic: 2.5 kg, 45 l, Z: 230 mm			•	•																
PD450M: 42 kg ±3%, Z: 150 mm							•	•	•											
PD510: 25 kg ±3%, Z: 60 mm	•	•	•	•	•	•														
PD700MR: 80 kg ±3%, Z: 120 mm							•	•	•	•	•	•	•	•	•	•	•	•	•	•
PD550RS: 45 kg ±3%, Z: 105 mm*							•	•	•	•										
PD600RS: 57 kg ±3%, Z: 115 / 105 mm*							•	•	•	•	•	•	•	•	•				•	
PD600RSD: 57 kg ±3%, Z: 115 / 105 mm*							•	•	•	•	•	•	•	•	•				•	
PD580RS: 65 kg ±3%, Z: 145 / 135 mm*							•	•	•	•	•	•	•	•	•				•	
PD800RS: 100 kg ±3%, Z: 110 / 100 mm*							•	•	•	•	•	•	•	•	•	•	•	•	•	•
PDU-B40: 118 kg ±3%, Z: 52 mm										•	•	•	•	•	•	•	•	•	•	•
PDUE-B50: 159 kg ±3%, Z: 53 mm										•	•	•	•	•	•	•	•	•	•	•
PDK5-B50: 173 kg ±3%, Z: 63 mm																				
PDK7-B40: 1000 kg ±3%, Z: 445 mm																				
PDZ: 5.5 kg, Z: 115 mm										•	•	•	•	•	•	•	•	•	•	•
PDZ5: 7 kg, Z: 115 mm																				
PDZ7: 48 kg ±3%, Z: 280 mm																				
PDUE-B50 RIO: 148 kg ±3%, Z: 136 mm																				
PDZ RIO: 10 kg, Z: 125 mm																				
PDKI-BCW: 155 kg, Z: 118 mm																				
PDZI: 12 kg, Z: 115 mm																				
PB370R15: 15 kg ±3%, Z: 50 mm	•	•	•	•	•	•														
PB370R25: 25 kg ±3%, Z: 80 mm	•	•	•	•	•	•														
PB450R40: 40 kg ±3%, Z: 90 mm																				
PDK50 Atlantic: 166 kg ±3%, Z: 140 mm																				
PDP 50 Atlantic: 19 kg ±3%																				
PDZ Atlantic: 8,2 kg ±3%																				

* Base type: standard tube / tube with a clamping knob

* Type de pieds : embout standard / embout avec bouton de serrage

• - Dedicated base / Pieds dédiée

○ - Optional base / Pieds en option



Bases Pieds

	Telescopic	Strong					Giant			Rectangular		Side Leg Rio	Side Leg Ibiza			Easy Up ETT			Telescopic ETT		Atlantic		Harmony EcoWay
	□	□	□	□	□	○	□	□	○	□	□	□	□	○	○	○	○	□	□				
	4 m	3 m	3.5 m	4 m	5 m	5.5 m	6 m	7 m	8 m	2 x 3 m	3 x 4 m	3 m	3.5 m	3.5 m	4.2 m	3 m	4 m	3 m	4 m				
BKR: 12 l, Z: 100 mm																							
Adriatic: 2.5 kg, 45 l, Z: 230 mm																							
PD450M: 42 kg ±3%, Z: 150 mm																							
PD510: 25 kg ±3%, Z: 60 mm																							
PD700MR: 80 kg ±3%, Z: 120 mm										•	•						•						
PD550RS: 45 kg ±3%, Z: 105 mm*																							
PD600RS: 57 kg ±3%, Z: 115 / 105 mm*										•						•		•					
PD600RSD: 57 kg ±3%, Z: 115 / 105 mm*										•						•		•					
PD580RS: 65 kg ±3%, Z: 145 / 135 mm*										•													
PD800RS: 100 kg ±3%, Z: 110 / 100 mm*	•	•								•	•												
PDU-B40: 118 kg ±3%, Z: 52 mm	•									•	•											•	
PDUE-B50: 159 kg ±3%, Z: 53 mm	•	•	•	•		•				•	•												
PDK5-B50: 173 kg ±3%, Z: 63 mm					•																		
PDK7-B40: 1000 kg ±3%, Z: 445 mm							•	•	•														
PDZ: 5.5 kg, Z: 115 mm	•	•	•	•		•				•	•					•	•	•	•				
PDZ5: 7 kg, Z: 115 mm					•																		
PDZ7: 48 kg ±3%, Z: 280 mm							•	•	•														
PDUE-B50 RIO: 148 kg ±3%, Z: 136 mm												•											
PDZ RIO: 10 kg, Z: 125 mm												•											
PDKI-BCW: 155 kg, Z: 118 mm													•	•	•								
PDZI: 12 kg, Z: 115 mm													•	•	•								
PB370R15: 15 kg ±3%, Z: 50 mm																							
PB370R25: 25 kg ±3%, Z: 80 mm																							
PB450R40: 40 kg ±3%, Z: 90 mm																							•
PDK50 Atlantic: 166 kg ±3%, Z: 140 mm																						•	
PDP 50 Atlantic: 19 kg ±3%																						•	
PDZ Atlantic: 8,2 kg ±3%																						•	

* Base type: standard tube / tube with a clamping knob

* Type de pieds : embout standard / embout avec bouton de serrage

• - Dedicated base / Pieds dédiée

○ - Optional base / Pieds en option



Suspended advertising system for sunshade parasols

Système de publicité suspendu sous un parasol

Telescopic / Strong



L (large) - Telescopic



S (small) - Telescopic



L (large) - Strong

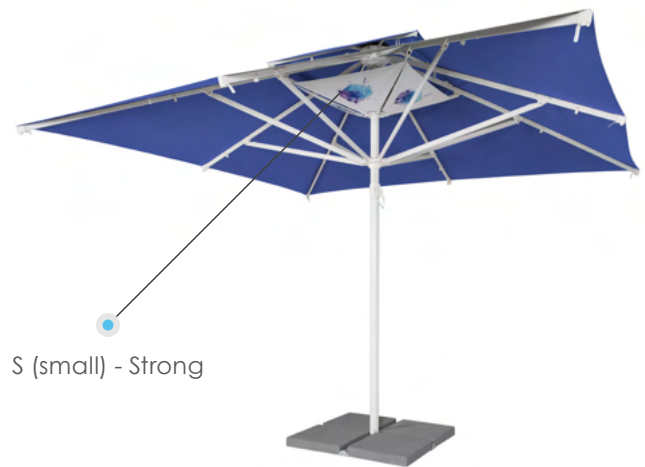

S (small) - Strong

	Telescopic		Strong	
	3,5 x 3,5 m	4 x 4 m	4 x 4 m	5 x 5 m
L size Taille L	☑	☑	☑	☑
S size Taille S	☑	☑	☑	☑



digital printing
impression numérique



flat printing
impression à plat



hand screen printing
impression en sérigraphie manuelle



Detachable wind valance for sunshade parasols

Bas-volets amovibles pour les parasols

Classic / Telescopic / Strong



	Classic		Telescopic		Strong	
	3,5 x 3,5 m	4 x 4 m	3,5 x 3,5 m	4 x 4 m	4 x 4 m	5 x 5 m
Size Taille	☑	☑	☑	☑	☑	☑



digital printing
impression numérique



flat printing
impression à plat



hand screen printing
impression en sérigraphie manuelle



Mobile system for parasol bases RS550 / RS580 / RS600 / RS800
Système mobile pour les pieds de parasol RS550 / RS580 / RS600 / RS800



Wind tunnel tests

Tests dans un tunnel aérodynamique



Permissible maximum wind speed

(values given on the basis of tests carried out in laboratory conditions)

Vitesse maximale admissible du vent

(valeurs indiquées sur la base d'essais réalisés dans les conditions de laboratoire)

The aesthetics goes for us hand in hand with the high quality and durability of the product. To confirm the optimal strength of our umbrellas, we subject them to demanding tests in the wind tunnel of the Warsaw Institute of Aviation. In addition, the fabrics used to produce the canopies of our umbrellas are tested, among others, in terms of their waterproof, water resistance and UV resistance. All these tests allow us to verify whether our product will meet such challenges as adverse weather conditions i.e. strong wind blowing, rainfall or exposure to the sun. This way, we can be sure that safe and high quality products are delivered into the hands of our customers.

Chez nous, l'apparence esthétique des produits doit aller de pair avec leur haute qualité. Pour confirmer la durabilité optimale de nos parasols, nous les testons dans le tunnel aérodynamique de l'Institut d'Aviation de Varsovie. De plus, les tissus utilisés pour la production de nos parasols sont examinés du point de vue de leur imperméabilité, déperlance et solidité des teintures à la lumière. Tous ces tests permettent de vérifier si nos produits vont répondre aux défis posés par des conditions atmosphériques défavorables comme des vents forts, des pluies ou l'exposition au soleil. Ainsi, nous pouvons être certains que nos clients recevront des produits sûrs et de haute qualité.

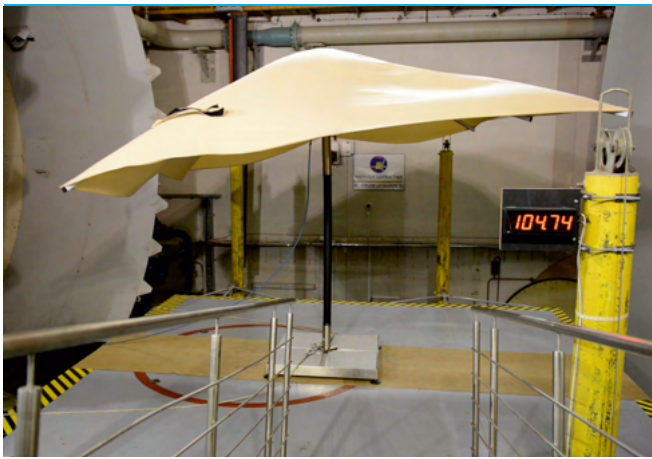
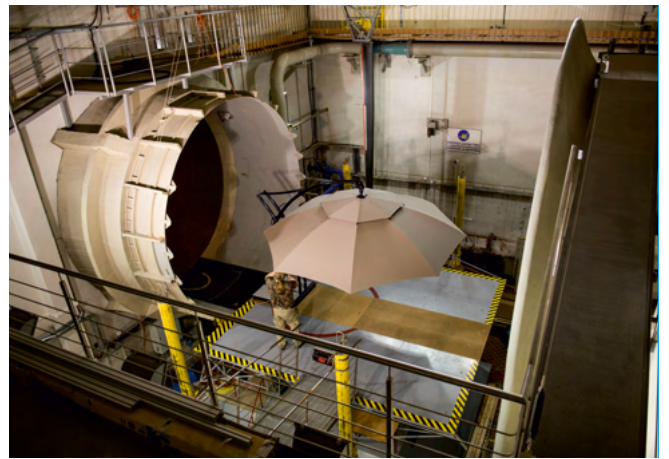





Awnings over terraces and restaurant gardens will allow you to arrange a unique and special place for your business. They are a great alternative to popular garden umbrellas. They provide an excellent shading area - a suitably selected size will shadow the entire area using just one awning. Due to the possibility of personalization of the sheathing, the awning will not only provide protection against weather conditions, but also is an eye-catching media for your advertising. The solutions applied in our products, such as sensors for closing the awning at a high wind, will improve their handling and the comfort of use.

Les auvents pour les jardins ou pour les terrasses de restaurants permettent d'aménager un lieu unique et exceptionnel. C'est une excellente alternative aux parasols de jardin. Ils assurent une surface d'ombrage parfaite - une taille bien choisie permet d'ombrager tout le jardin avec un seul auvent. Grâce à la possibilité de personnalisation de la toile, les marquises constituent non seulement la protection contre les conditions atmosphériques, mais aussi un support de publicité qui attire l'attention des clients. Les solutions disponibles comme p.ex. des capteurs fermant la marquise au cas de vent important, assurent l'utilisation facile et confortable.



Shade sail / Voile d'ombrage



	4,8	6,7	3,3	4,0	5,0	3,3 x 4,8	5,0 x 6,5
Shade sail shape Forme de la voile	triangle	triangle	square carré	square carré	square carré	rectangle	rectangle
Shade sail dimensions [m] Dimensions de la voile [m]	4,8 x 4,8 x 4,8	6,7 x 6,7 x 6,7	3,3 x 3,3	4,0 x 4,0	5,0 x 5,0	3,3 x 4,8	5,0 x 6,5

Cover Toile	acrylic fabric issu acrylique
Variable shade sail angle Angle d'inclinaison de la voile variable	yes oui
Possibility to join units Possibilités de raccorder quelques voiles	yes oui
Frame colour Couleur de la structure	anoda Anode
Installation Type de fixatio	to elevation, to ground sur la façade, au sol
Opening system Système d'ouverture	handle with winding system poignée avec un système de tension



Pergola Standard



Width of construction [mm] Largeur de la structure [mm]	Min – 2000 Max – 7000
Outreach of construction [mm] Avancée de la construction [mm]	Min – 2000 Max – 5000
Pergola height [mm] Hauteur de pergola [mm]	2500
Possibility to join units Possibilités de raccorder quelques systèmes	yes oui
Cover Toil	acrylic fabric tissu acrylique
Frame colour Couleur de la monture	any from RAL colour palette chaque couleur de la palette RAL
Installation Type de fixation	ree-standing, to elevation + legs from front, to elevation autoportée, adossée + pieds, adossée
Opening system Système d'ouverture	manual manuel

Optional / En option :

- + possibility to make the pergola in other than the standard height
possibilité de commander une pergola de hauteur non standard

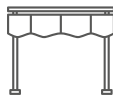

Duetto Classic



Width [m] / Largeur [m]	4,2 - 12,0	4,2 - 12,0	4,2 - 12,0	4,2 - 12,0
Outreach [m] / Avancée [m]	2,0	2,5	3,0	3,5
Weight [kg / mb] / Poids [kg / lfm]	60	60	60	60

Cover / Toile	acrylic, Airtex (PVC-coated polyester), polyester / acrylique, Airtex (polyester enduit de PVC), polyester
Printing techniques Technique d'impression	screen printing (polyester, acrylic), digital printing (Airtex) sérigraphie (polyester, acrylique), impression numérique (Airtex)
Frame colour / Couleur de la monture	cream, white, anthracite / crème, blanche, anthracite
Valance / Bas-volets	straight or wavy / droit ou ondulé (concerne le volant)
Inclination angle/ Angle d'inclinaison	5° - 60°
Wind class / Classe de vent	1 or 2 / 1 ou 2
Installation / Type de fixation	freestanding / sur pied
Opening system / Système d'ouverture	crank / manivelle
Packing / Emballage	cardboard box 30 cm x 30 cm x (width + ~20 cm) / une boîte en carton 30 cm x 30 cm x (largeur + ~20 cm)

Optional / En option :

- + electric motor, steering remote / moteur électrique, télécommande
- + weather station / station météo
- + lighting / éclairage
- + telescopic supports to reinforce the awning structure - cannot be used with the weather station / stabilisateurs télescopiques pour auvent - ils ne peuvent pas être utilisés avec une station météo



Barcelona

Cassette-free awning / Marquise sans cassette



Width [m] / Largeur [m]	2,4 - 7,2	2,4 - 7,2	3,0 - 12,0	3,6 - 12,0	4,2 - 12,0	4,8 - 12,0
Outreach [m] / Avancée [m]	1,5	2,0	2,5	3,0	3,5	4,0
Weight [kg / mb] / Poids [kg / lfm]	12	12	13	13	13	14

Cover / Toile	acrylic, Airtex (PVC-coated polyester), polyester / acrylique, Airtex (polyester enduit de PVC), polyester
Printing techniques Technique d'impression	screen printing (polyester, acrylic), digital printing (Airtex) sérigraphie (polyester, acrylique), impression numérique (Airtex)
Frame colour / Couleur de la monture	white, brown, grey, anthracite / blanc, brun, gris, anthracite
Valance / Bas-volets	straight or wavy / droit ou ondulé (concerne le volant)
Inclination angle/ Angle d'inclinaison	5° - 60°
Wind class / Classe de vent	1 or 2 / 1 ou 2
Installation / Type de fixation	to the facade / sur la façade
Opening system / Système d'ouverture	crank / manivelle
Packing / Emballage	cardboard box 30 cm x 30 cm x (width + ~20 cm) / une boîte en carton 30 cm x 30 cm x (largeur + ~20 cm)

Optional / En option :

- + electric motor, steering remote + weather station + lighting
- moteur électrique, télécommande station météo éclairage
- + telescopic supports to reinforce the awning structure - cannot be used with the weather station
- stabilisateurs télescopiques pour auvent - ils ne peuvent pas être utilisés avec une station météo



California

Semi-cassette awning / Marquise à demi-cassette



Width [m] / Largeur [m]	2,4 - 7,2	2,4 - 7,2	3,0 - 7,2	3,6 - 7,2	4,2 - 7,2	4,8 - 7,2
Outreach [m] / Avancée [m]	1,5	2,0	2,5	3,0	3,5	4,0
Weight [kg / mb] / Poids [kg / lfm]	14	14	15	15	15	16

Cover / Toile	acrylic, Airtex (PVC-coated polyester), polyester / acrylique, Airtex (polyester enduit de PVC), polyester
Printing techniques Technique d'impression	screen printing (polyester, acrylic), digital printing (Airtex) sérigraphie (polyester, acrylique), impression numérique (Airtex)
Frame colour / Couleur de la monture	white, brown, grey, anthracite / blanc, brun, gris, anthracite
Valance / Bas-volets	straight or wavy / droit ou ondulé (concerne le volant)
Inclination angle/ Angle d'inclinaison	5° - 60°
Wind class / Classe de vent	1 or 2 / 1 ou 2
Installation / Type de fixation	to the facade / sur la façade
Opening system / Système d'ouverture	crank / manivelle
Packing / Emballage	cardboard box 30 cm x 30 cm x (width + ~20 cm) / une boîte en carton 30 cm x 30 cm x (largeur + ~20 cm)

Optional / En option :

- + electric motor, steering remote
 moteur électrique, télécommande
 - + weather station
 station météo
 - + lighting
 éclairage
- + telescopic supports to reinforce the awning structure - cannot be used with the weather station
 stabilisateurs télescopiques pour auvent - ils ne peuvent pas être utilisés avec une station météo



Palermo

Full-cassette awning / Marquise à cassette complète



Width [m] / Largeur [m]	2,4 - 7,2	2,4 - 7,2	3,0 - 7,2	3,6 - 7,2	4,2 - 7,2
Outreach [m] / Avancée [m]	1,5	2,0	2,5	3,0	3,5
Weight [kg / mb] / Poids [kg / lfm]	14	14	15	15	15

Cover / Toile	acrylic, Airtex (PVC-coated polyester), polyester / acrylique, Airtex (polyester enduit de PVC), polyester
Printing techniques Technique d'impression	screen printing (polyester, acrylic), digital printing (Airtex) sérigraphie (polyester, acrylique), impression numérique (Airtex)
Frame colour / Couleur de la monture	white, brown, grey, anthracite / blanc, brun, gris, anthracite
Valance / Bas-volets	straight or wavy / droit ou ondulé (concerne le volant)
Inclination angle/ Angle d'inclinaison	5° - 60°
Wind class / Classe de vent	1 or 2 / 1 ou 2
Installation / Type de fixation	to the facade / sur la façade
Opening system / Système d'ouverture	crank / manivelle
Packing / Emballage	cardboard box 30 cm x 30 cm x (width + ~20 cm) / une boîte en carton 30 cm x 30 cm x (largeur + ~20 cm)

Optional / En option :

+ electric motor, steering remote
moteur électrique, télécommande

+ weather station
station météo

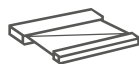

Roma

Full-cassette awning / Marquise à cassette complète



Width [m] / Largeur [m]	3,0 - 6,0	3,0 - 6,0	4,2 - 6,0
Outreach [m] / Avancée [m]	2,5	3,0	3,5
Weight [kg / mb] / Poids [kg / lfm]	15	15	15

Cover / Toile	acrylic, Airtex (PVC-coated polyester), polyester / acrylique, Airtex (polyester enduit de PVC), polyester
Printing techniques Technique d'impression	screen printing (polyester, acrylic), digital printing (Airtex) sérigraphie (polyester, acrylique), impression numérique (Airtex)
Frame colour / Couleur de la monture	white, grey, anthracite / blanc, gris, anthracite
Valance / Bas-volets	straight or wavy / droit ou ondulé (concerne le volant)
Inclination angle/ Angle d'inclinaison	5° - 60°
Wind class / Classe de vent	1, 2 or 3 / 1, 2 ou 3
Installation / Type de fixation	to the facade / sur la façade
Opening system / Système d'ouverture	electric motor (Somfy) / moteur électrique (Somfy)
Packing / Emballage	cardboard box 30 cm x 30 cm x (width + ~20 cm) / une boîte en carton 30 cm x 30 cm x (largeur + ~20 cm)

Optional / En option :

- + weather station
station météo



Andaluzja

Markiza bezkasetowa / Offene Markise



Width [m] / Largeur [m]	3,1 - 6,0	3,6 - 6,0	4,2 - 6,0	4,2 - 6,0
Outreach [m] / Avancée [m]	2,5	3,0	3,0	3,5
Weight [kg / mb] / Poids [kg / lfm]	14	14	14	14

Cover / Toile	acrylic, Airtex (PVC-coated polyester), polyester / acrylique, Airtex (polyester enduit de PVC), polyester
Printing techniques / Technique d'impression	screen printing (polyester, acrylic), digital printing (Airtex) / sérigraphie (polyester, acrylique), impression numérique (Airtex)
Frame colour / Couleur de la monture	cream, grey, anthracite / crème, gris, anthracite
Valance / Bas-volets	straight or wavy / droit ou ondulé (concerne le volant)
Inclination angle / Angle d'inclinaison	5° - 30°
Open arms angle / Angle du bras ouverts	140° and 170° / 140° et 170°
Wind class / Classe de vent	1 or 2 / 1 ou 2
Installation / Type de fixation	to the facade / sur la façade
Opening system / Système d'ouverture	crank / manivelle
Packing / Emballage	cardboard box 30 cm x 30 cm x (width + ~20 cm) / une boîte en carton 30 cm x 30 cm x (largeur + ~20 cm)

Optional / En option :

- + electric motor, steering remote / moteur électrique, télécommande
- + weather station / station météo
- + telescopic supports to reinforce the awning structure - cannot be used with the weather station / stabilisateurs télescopiques pour auvent - ils ne peuvent pas être utilisés avec une station météo



Why awnings and terrace roofings? Pourquoi des marquises et des auvents ?

- Sensors closing the awning at high wind.
Capteurs qui ferment la marquise en cas de vent.
- Personalization.
Possibilité de personnalisation.
- Large shading area.
Grande surface d'ombrage.
- Easy to maintain.
Facilité d'entretien.





Available sizes / Tailles disponibles

		Width Largeur									
Outreach [m] Avancée [m]		3,6	4,2	4,8	5,4	6,0	7,2	8,4	9,6	10,8	12,0
Duetto Classic	2.0		•	•	•		•	•	•	•	•
	2.5		•	•	•	•	•	•	•	•	•
	3.0		•	•	•	•	•	•	•	•	•
	3.5		•	•	•	•	•	•	•	•	•
Barcelona	2.5	•	•	•	•	•	•	•	•	•	•
	3.0		•	•	•	•	•	•	•	•	•
	3.5		•	•	•	•	•	•	•	•	•
California	2.5	•	•	•	•	•	•				
	3.0		•	•	•	•	•				
	3.5		•	•	•	•	•				
	4.0			•	•	•	•				
Palermo	2.0	•	•	•	•						
	2.5	•	•	•	•						
	3.0		•	•	•						

Do you need more information? Ask for a dedicated product catalogue. / Avez-vous besoin de plus amples informations ? Demandez un catalogue de produits dédié.



neotent™



More than advertising
Plus que de la publicité

Tents. There are no two identical events. With this in mind, we have created solutions tailored to different clients and industries. We have also taken into account the weather conditions and limited possibilities that can be encountered during the organization. NEOtent™ is two amazing solutions, with many possible configurations. NEOtent™ Standard has been created for economic users who value comfort, quality and product availability, as well as for spare parts. NEOtent™ Plus is a version for very demanding clients. It is characterized by a reinforced frame and the use of elements covered even by a lifetime manufacturer's warranty. Regardless of which solution you consider the best for your company, by choosing NEOtent™, you have a guarantee of a good investment and a great way to present your brand.

Tentes. Il n'y a pas deux événements identiques. C'est pourquoi nous avons créé des solutions qui s'adaptent aux différents besoins des clients et aux différents types d'activité. Nous avons également pris en compte les conditions météorologiques et les possibilités limitées qui pourraient constituer un obstacle lors de l'organisation d'un événement. NEOtent™ Standard et Plus – ce sont deux solutions extraordinaires avec de nombreuses configurations possibles. NEOtent™ Standard a été créé pour les utilisateurs qui apprécient le confort, la qualité et l'accessibilité du produit. NEOtent™ Plus est une version destinée aux clients très exigeants. Cette tente se distingue par sa monture renforcée avec des éléments couverts par une garantie à vie. Quelle que soit la version que vous considérez comme la meilleure pour votre entreprise, en choisissant NEOtent™ vous avez la garantie d'un bon investissement et d'un moyen efficace pour promouvoir votre marque.



neotent™

STANDARD



	2 x 2	2 x 3	2 x 4	2,5 x 2,5	3 x 3	3 x 4,5	3 x 6	4 x 4
A ₁ [mm]	2070	2070	2070	2550	3050	3050	3050	3
A ₂ [mm]	2070	3050	4000	2550	3050	4030	6000	4030
B [mm]	2260 - 2460	2260 - 2460	2260 - 2460	2260 - 2460	2260 - 2460	2260 - 2460	2260 - 2460	2260 - 2460
C [mm]	2860 - 3060	2860 - 3060	2860 - 3060	3100 - 3300	3260 - 3460	3260 - 3460	3260 - 3460	3680 - 3880
D [mm]	330	330	330	330	330	330	330	330
E	30°	30°	30°	30°	30°	30°	30°	30°
Tent weight [kg] (frame + roof canopy) Poids de la tente [kg] (monture + toit)	~ 17,5	~ 21,5	~ 25,0	~ 19,0	~ 21,0	~ 25,5	~ 28,7	~ 24,0

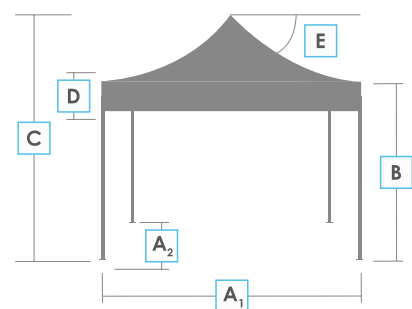
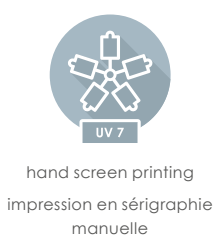
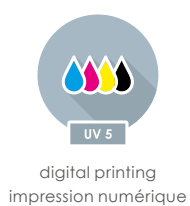

Wall types Types de murs



A rich basic colours palette of the sheathing Riche palette de couleurs pour les toiles

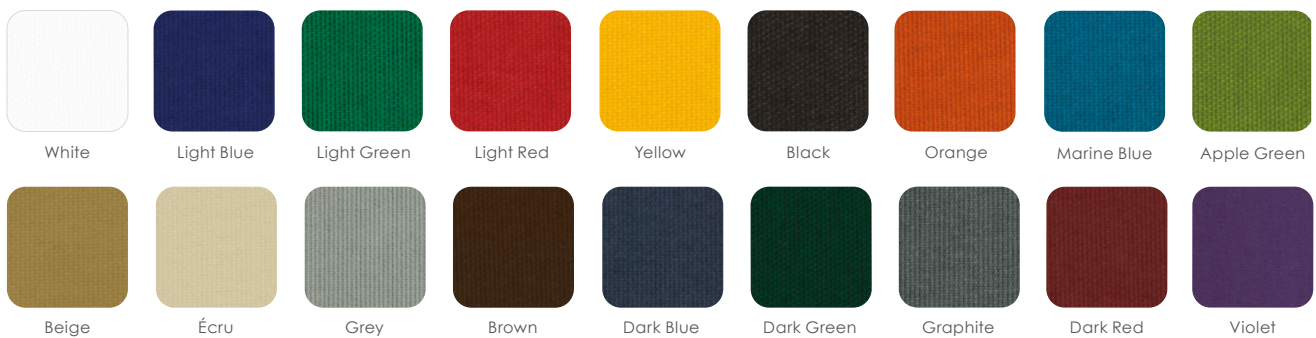

We use a water repellent fabric with a weight of 235 g/m².
Nous utilisons des tissus avec traitement déperlant d'un poids de 235 g/m².

Do you need more information? Ask for a dedicated product catalogue.
Avez-vous besoin de plus amples informations ? Demandez un catalogue de produits dédié.



neotent™

PLUS

Larger advertising area.
Espace publicitaire plus grand.

Ease of adjustment.
Ajustement facile.



Quality confirmed by standards.
Qualité confirmée par les normes.

High quality printing.
Impression de haute qualité.

Version for demanding clients.
Version pour les clients exigeants.

	3 x 3	3 x 4,5	3 x 6	4 x 4	4 x 8
A ₁ [mm]	3050	4550	6000	4050	8000
A ₂ [mm]	3050	3050	3050	4050	4050
B [mm]	2270 - 2470	2270 - 2470	2270 - 2470	2270 - 2470	2270 - 2470
C [mm]	3300 - 3500	3300 - 3500	3300 - 3500	3700 - 3900	3700 - 3900
D [mm]	380	380	380	380	380
E	33°	33°	33°	33°	33°
Tent weight [kg] (frame + roof canopy) Poids de la tente [kg] (monture + toit)	~ 25	~ 30	~ 34	~ 29	~ 55



UV 5
digital printing
impression numérique



UV 7
flat printing
impression à plat



UV 7
hand screen printing
impression en sérigraphie
manuelle



woven fabric
toile tissée

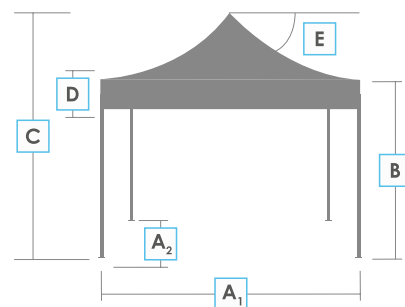

Wall types Types de murs

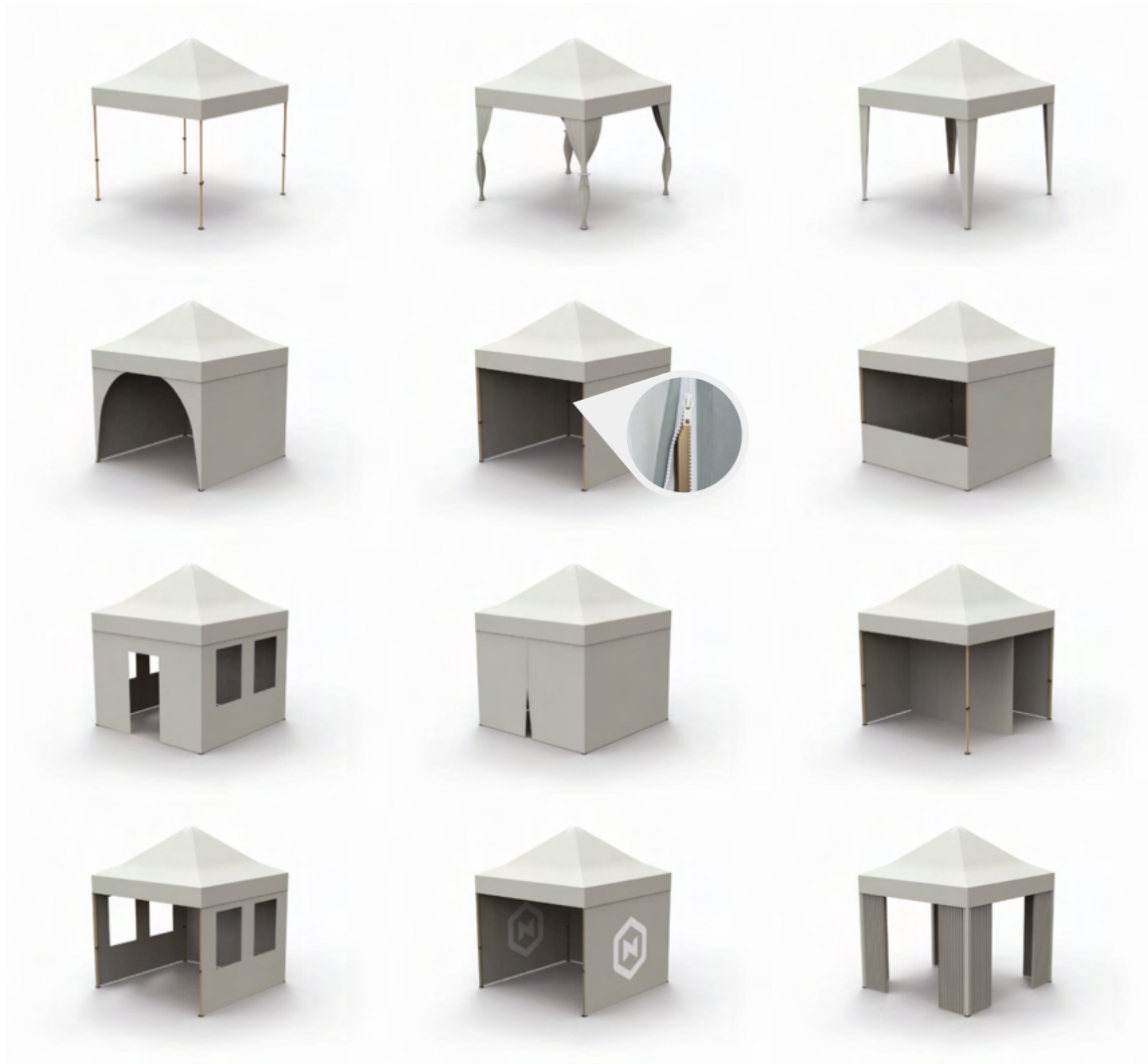

A rich basic colours palette of the sheathing Riche palette de couleurs pour les toiles

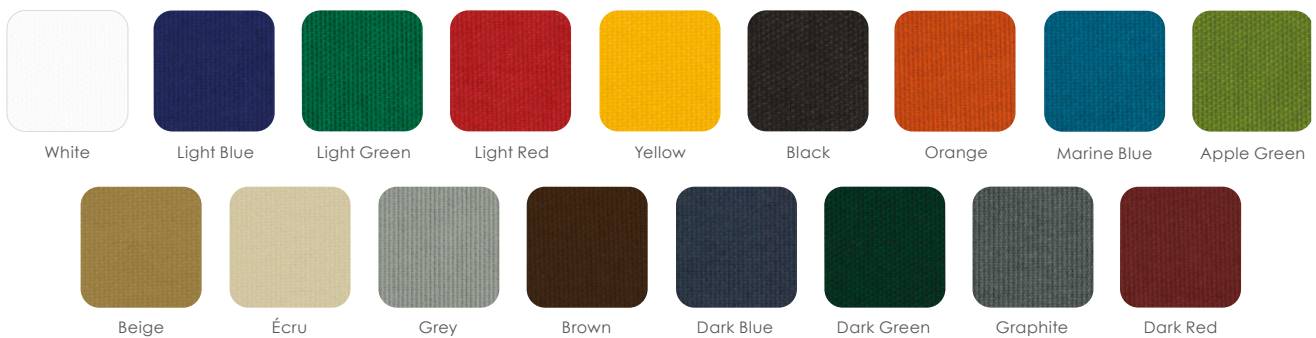

We use a water repellent fabric with a weight of 235 g/m².
Nous utilisons des tissus avec traitement déperlant d'un poids de 235 g/m².

Do you need more information? Ask for a dedicated product catalogue.
Avez-vous besoin de plus amples informations ? Demandez un catalogue de produits dédié.



Flags, banners, beachflags Drapeaux, banderoles, beachflags

The simplest and most effective tools that can be used in inexpensive way to carry out promotional campaigns and attract customers. Advertising banners and flags are extremely popular products used to show off a brand. They are often considered to be an optimal marketing solution because they are long-lasting, relatively cheap and easily attract customers' attention.

Ils constituent un moyen le plus simple, le plus efficace et en même temps le moins cher, avec lequel vous pouvez mener les campagnes promotionnelles pour attirer des clients. Les banderoles publicitaires et les drapeaux sont des produits très populaires pour afficher la marque. Ils sont considérés souvent comme une solution de marketing optimale, car ils sont durables, relativement peu coûteux et en plus, ils attirent facilement l'attention des clients.

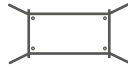

Banners / Banderoles



PVC banners Banderoles en PVC	
Size Taille	on a 50 m roller en rouleau de 50 m
	the possibility of cutting the banner to size possibilité de découpe sur mesure
Standard confection Confection standard	heat sealed at the edges and eyeleted soudée aux 4 cotés avec œillets
	cut „sharp” with eyeleted coupe franche avec œillets
	cut „sharp” without eyelets coupe franche sans œillets

Textile banners Banderoles textiles	
Size Taille	on a 50 m roller en rouleau de 50 m
	the possibility of cutting the banner to size possibilité de découpe sur mesure
Standard confection Confection standard	cut, eyelets every 50 cm, trimming tape or hem as an option coupe, œillets tous les 50 cm, sangle de renfort ou ourlet en option



UV 6-7
eco-solvent printing
impression à éco-solvant



PVC



UV 5
digital printing
impression numérique



UV 7
flat printing
impression à plat



woven fabric
toile tissée



knitted fabric
toile tricotée

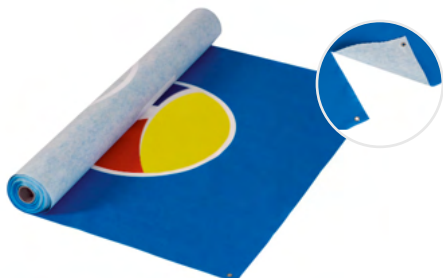

Non-woven banners Banderoles en non-tissé	
Standard size [m] Taille standard [m]	2,5 x 0,97 on a 25 m roller 2,5 x 0,97 en rouleau de 25 m
	the possibility of cutting the banner to size possibilité de découpe sur mesure
Standard confection Confection standard	thermal cut, eyelets every 50 cm, possibility of perforation coupe à chaud, œillets tous les 50 cm, prédécoupage en option



UV 5
digital printing
impression numérique



nonwoven fabric
non-tissé



Beachflag Square Alu



Type and colour of frame Type et couleur de monture	aluminium, gray aluminium, gris
Type of fabric Type de textile	knitted fabric 112 g/m ² ±6 g toile tricotée 112 g/m ² ±6 g

Available sizes [mm] Tailles disponibles [mm]	Actual Size (Flag with frame) Taille réelle (mât avec voile)	Flag size Dimensions de la voile
		600 x 2000
	600 x 2500	600 x 2000
	600 x 3000	600 x 2500
	800 x 3500	800 x 3000

Transport - packing Transport - emballage	transport bag + carton sac de transport + carton
--	---



digital printing
impression numérique



knitted fabric
maille



Beachflag Angle Alu



Type and colour of frame Type et couleur de monture	aluminium, gray aluminium, gris
Type of fabric Type de textile	knitted fabric 112 g/m ² ±6 g toile tricotée 112 g/m ² ±6 g

Available sizes [mm] Tailles disponibles [mm]	Actual Size (Flag with frame) Taille réelle (mât avec voile)	Flag size Dimensions de la voile
		600 x 2000
	600 x 2500	600 x 2000
	600 x 3000	600 x 2500
	900 x 3500	900 x 2800
	900 x 4000	900 x 3300
	900 x 4500	900 x 3800
	900 x 5000	900 x 4300

Transport - packing Transport - emballage	transport bag + carton sac de transport + carton
--	---



digital printing
impression numérique



knitted fabric
maille



Beachflag Drop Glass



Type and colour of frame Type et couleur de monture	aluminum frame + glass fiber, black monture en aluminium + fibre de verre, noir
Type of fabric Type de textile	knitted fabric 112 g/m ² ±6 g toile tricotée 112 g/m ² ±6 g

Available sizes [mm] Tailles disponibles [mm]	Actual Size (Flag with frame) Taille réelle (mât avec voile)	Flag size Dimensions de la voile
		600 x 2600
	600 x 3100	600 x 2400
	900 x 4100	900 x 3000
	900 x 5200	900 x 4000

Transport - packing Transport - emballage	transport bag + carton sac de transport + carton
--	---



digital printing
impression numérique



knitted fabric
maille



Beachflag Wing Glass



Type and colour of frame Type et couleur de monture	aluminum frame + glass fiber, black monture en aluminium + fibre de verre, noir
Type of fabric Type de textile	knitted fabric 112 g/m ² ± 6 g toile tricotée 112 g/m ² ± 6 g

Available sizes [mm] Tailles disponibles [mm]	Actual Size (Flag with frame) Taille réelle (mât avec voile)	Flag size Dimensions de la voile
		600 x 2600
	600 x 3100	600 x 2400
	900 x 4100	900 x 3200
	900 x 5200	900 x 4200

Transport - packing Transport - emballage	transport bag + carton sac de transport + carton
--	---



digital printing
impression numérique



knitted fabric
maille



Accessories / Accessoires

Premium Bag for BeachFlag / Sac Premium pour BeachFlag



15,5 x 120 [cm]

BeachFlag base weights / Lestage pour les pieds de beachflags



1 x 20 kg



2 x 15 kg



1 x 10 kg

Cross shaped base / Pied croisillon



600 X 600 X 30 [mm], 2,3 kg



600 x 600 x 30 [mm], 3,6 kg



1000 X 1000 x 40 [mm], 8,4 kg

Metal plate base / Pied platine en acier

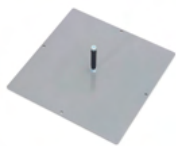

300 x 300 [mm], 2,2 kg

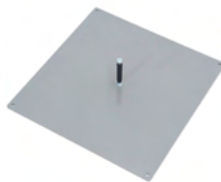

400 x 400 [mm], 5,4 kg

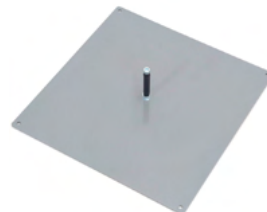

500 x 500 [mm], 10 kg

Concrete base suitcase with handle Pied en béton en forme de valise avec poignée



PB 370 R15: 370 x 390 x 50 [mm], 15 kg

PB 370 R25: 370 x 370 x 80 [mm], 25 kg

* possibility of branding through a permanent sticker / possibilité de marquage avec un autocollant permanent

Plastic screw base Pied tire-bouchon en plastique



Pins L-270 / Sardines



Flags / Drapeau



	Vertical flags Drapeaux verticaux	Horizontal flags Drapeaux horizontaux
Size [cm] Taille [cm]	width / largeur : 100 / 200 / 250 / 300 / 350 / 400 height / hauteur : 150 / 120 / 100 / 80	100 x 120, 100 x 150, 200 x 150
Type of fabric Type de textile	woven fabric / polystrech / satin / double-sided satin / spun toile tissée / polystretch / satin / satin double face / spun	
Finishing options Possibilités de finition	pole-tuning, carabiner clips, eyelets, rope / loop fourreau sur le mât, mousquetons, œillets, corde / nœud	
Accessories	plastic / polyamid clamping rings for masts, velcro tape, carabiner clips, mast weights, steel and plastic eyelets clips en plastique / polyamide pour mâts, bande velcro, mousquetons, contreponds pour mât, œillets en acier et en plastique	



digital printing
impression numérique



flat printing
impression à plat

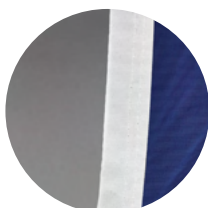

Trimming tape
Sangle de renfort



Snap hook
Mousqueton

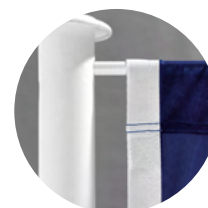

Tunnel
Fourreau



A photograph of an outdoor cafe area. In the foreground, a table is covered with a red and white checkered tablecloth. A white patio umbrella with a dark logo is partially visible on the left. In the background, there are green trees and a light-colored building with windows. A semi-transparent blue rectangle is overlaid on the center of the image, containing two paragraphs of text.

Advertising can be an attractive and practical decoration. Standard textile advertising solutions that allow for the display of logos and brand promotion invariably boast a high popularity. Due to the high quality of print your tablecloths, aprons or pillows will not only surprise you with their functionality, but also please the eye with vibrant colours and high precision in reproducing details.

La publicité peut être la décoration attrayante et pratique. Les textiles publicitaires qui permettent l'exposition de logo et la promotion de marque jouissent toujours d'une grande popularité. Grâce à l'impression de haute qualité, vos nappes, tabliers et coussins vont se distinguer non seulement par leur fonctionnalité, mais aussi par leurs couleurs vives et par une grande précision du rendu des détails.



Tablecloth / Nappes



Dimensions [m]	3 x 1,5	2,5 x 1,5	2 x 1,5	1,5 x 1,5	2 x 1	1,5 x 1
	the possibility of cutting the tablecloth to size possibilité de découpe sur mesure					
Standard confection Confection standard	sewing around ourlet tout autour					



digital printing
impression numérique



woven fabric
toile tissée

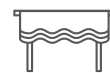

Mesh tablecloth / Nappes en Mesh microperforé

Type of fabric Type de textile	PVC Mesh bâche micro-perforée Mesh
Dimensions	cut to size sur mesure



eco-solvent printing
impression à éco-solvant



PVC



Decorative cushions Coussins décoratifs



Type of fabric Type de textile	polyester fabric toile polyester
Dimensions [cm]	60 x 40
Options	with or without a zipper confection avec ou sans fermeture éclair
Filling Remplissage	silicone boule de silicone



digital printing
impression numérique



woven fabric
toile tissée



Aprons / Tabliers de sommelier

Type of fabric Type de textile	polyester fabric toile polyester
Dimensions [cm]	75 x 55
Options	confection with or without pocket confection avec ou sans poche



digital printing
impression numérique



woven fabric
toile tissée



Bartender's aprons Tabliers de barman

Type of fabric Type de textile	polyester fabric toile polyester
Dimensions [cm]	90 x 80



digital printing
impression numérique



woven fabric
toile tissée





Furniture and accessories Meubles et accessoires

Every event requires a proper branding. How to do it better than by decorating it with your own branded deckchairs and café barriers? These are the most convenient solutions for managing smaller and larger spaces, both inside and outside. The compositions of these elements will complement each area appropriately, constituting its aesthetic and functional variety.

Chaque événement nécessite une ambiance bien adaptée. Comment le faire mieux qu'avec vos propres transats ou séparateurs de terrasse personnalisés ? C'est la proposition très pratique pour aménager de petits ou grands espaces, aussi bien à l'extérieur qu'à l'intérieur. Vous pouvez équiper chaque lieu de vente de votre propre composition de ces meubles en y apportant des valeurs esthétiques et pratiques.



Wooden deckchair / Transat en bois



	LX*	LZ*
Type of fabric Toile	polyester fabric Toile tissée	
Seat Siège	single- or double-sided, exchangeable seat siège amovible, impression recto ou recto-verso	
Frame Cadre	natural, unimpregnated beech wood bois de hêtre naturel	
Dimensions [mm]	1310 x 560 x 32	1270 x 570 x 31

*rtype of deck chairs will depend on availability / le type de transat dépend



digital printing
impression numérique



flat printing
impression à plat



woven fabric
toile tissée

	Additional options Options supplémentaires
Valance at the back of the deck chair [mm] Volant [mm]	425 x 150
Drink holder Porte-gobelet	one coloured polyester fabric beige, easy assembly - disassembly tissu polyester unicolore beige, facile montage - démontage
Cushion for the deck chair Coussin	dimensions: 430 x 215 mm, polyester fabric, print: digital transfer dimensions : 430 x 215 mm, tissu polyester, impression : numérique



Repost barrier post / Séparateurs REPOST



Height [cm] / weight [kg] Taille [cm] / poids [kg]	85 / 8
Tape (length x width) [m x cm] Ruban (longueur x largeur) [m x cm]	3 x 5
Advantages Avantages	Digital print on the tape as an option Impression numérique sur la bande en option
	Tape fastened with a magnet Ruban fixé avec un aimant



Aluminium deck chair / Transat en aluminium

WHAT'S NEW?



The Litex Promo aluminium deck chair is **OBAC certified** for safe product use!

La transat Litex Promo en aluminium est **certifiée OBAC** pour une utilisation sûre du produit !

High quality digital imprint allows you to create any design you want – you decide yourself as to what can be placed on the deckchair cover, cushion or frills.

L'impression numérique de haute qualité permet de réaliser n'importe quel motif – vous décidez de ce qui se trouve sur la toile, le coussin ou le volant du transat.

CERTIFIED PRODUCT
PRODUIT CERTIFIÉ

The frame of the deckchair is 100% made of aluminium.

Le châssis de transat est fait en 100 % aluminium.

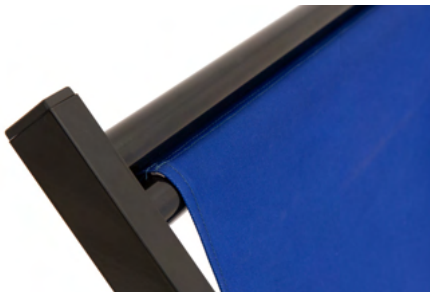

Folded dimensions [mm] Dimensions après pliage [mm]	A: 1310 B: 90 C: 575		
Unfolded dimensions [mm] Dimensions déplié [mm]	A ₁ : 410 B ₁ : 1020 C ₁ : 970	A ₂ : 365 B ₂ : 1035 C ₂ : 860	A ₃ : 315 B ₃ : 1070 C ₃ : 730

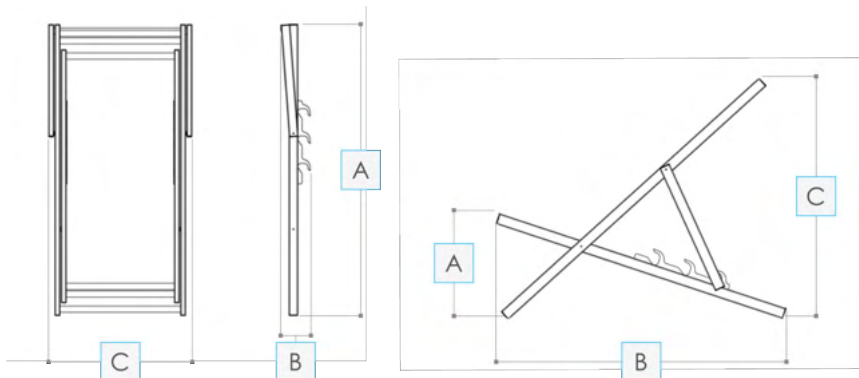

Printing techniques / Technique d'impression



digital printing
impression numérique



flat printing
impression à plat

Nośnik / Artikel



woven fabric
toile tissée

Type of fabric Toile	polyester fabric Toile tissée
Seat Siège	single- or double-sided, exchangeable seat siège amovible, impression recto ou recto-verso
Type and colour of frame Type et couleur de monture	powder-coated aluminum, black aluminium enduit de poudre, noir

	Additional options Options supplémentaires
Valance at the back of the deck chair [mm] Volant [mm]	435 x 250
Cushion for the deck chair Coussin	dimensions: 470 x 160 mm, polyester fabric, print: digital transfer dimensions : 470 x 160 mm, tissu polyester, impression : numérique

Packing Emballage	2 pcs in a cardboard box 2 pièces dans une boîte en carton
Package dimension [mm] Dimension du colis [mm]	1320 x 100 x 590
Weight of a single deckchair [kg] Poids d'un seul transat [kg]	3,5
Weight with packaging [kg] Poids avec l'emballage [kg]	8





Café barriers / Séparateurs de terrasse

Premium



Barrier type Type de séparateur de terrasse	1 m	1,5 m	2 m
Purpose of use Utilisation	1124 x 340 x 1045	1624 x 340 x 1045	2124 x 340 x 1045
Weight of span with 1 layer of base [kg] Poids du séparateur avec 1 couche de base [kg]	17,2	17,7	18,1

Base	indoor - 1 pc., outdoor 2 or 3 pcs in door - 1 pièces, out door 2 au 3 pièces
Base types Types de base	flat (stainless steel) or profiled (stainless steel) plate (acier inoxydable) ou profilée (acier inoxydable)
Base weight [kg] Poids de la base [kg]	flat plate: 4,3, profiled plate: 2,35 plaque plate : 4,3, plaque profilée : 2,35

Material Matériel	polished stainless steel acier poli résistant aux acides		
Printing techniques Technique d'impression	single- or double-sided* printing on knitted fabric impression recto ou recto-verso* sur maille polyester		
Banner dimensions [cm] Dimensions de la bannière [cm]	90 x 80	140 x 80	190 x 80

*two layers of knitted fabric with a divider
deux couches de toile + une couche opacifiante



indoor
in door



indoor
in door

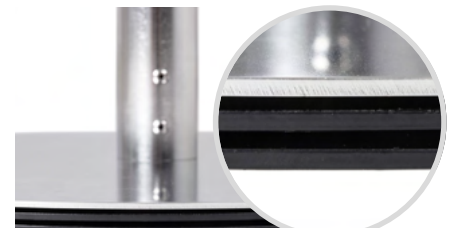

outdoor - 1 to 3 plates can be added to one post,
thus regulating its load
out door - des plaques peuvent être ajoutées pour
une stabilisation supplémentaire

Premium barriers available with a CLICK type quick coupler (photo no. 1) or with a screw attachment (photo no. 2).
Séparateurs Premium disponibles avec une attache rapide type CLICK (photo 1) ou avec montage à vis (photo 2).



Café barriers / Séparateurs de terrasse

Economic



Barrier type Type de séparateur de terrasse	1 m	1,5 m	2 m
Purpose of use Utilisation	1124 x 340 x 1045	1624 x 340 x 1045	2124 x 340 x 1045
Weight of span with 1 layer of base [kg] Poids du séparateur avec 1 couche de base [kg]	17,2	17,7	18,1

Base	indoor - 1 pc., outdoor 2 or 3 pcs in door - 1 pièces, out door 2 au 3 pièces
Base types Types de base	flat (powder painted) plat (revêtement en poudre)
Base weight [kg] Poids de la base [kg]	flat plate: 4,3 plaque plate : 4,3

Material Matériel	galvanized steel, powder coated acier galvanisé, revêtement en poudre
Printing techniques Technique d'impression	single- or double-sided* printing on knitted fabric impression recto ou recto-verso* sur maille polyester
Banner dimensions [cm] Dimensions de la bannière [cm]	90 x 80 140 x 80 190 x 80

*two layers of knitted fabric with a divider
deux couches de toile + une couche opacifiante

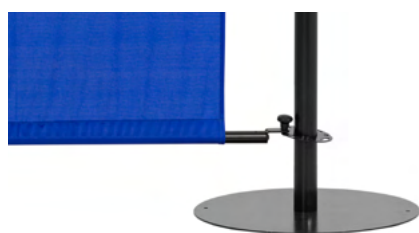

indoor
in door

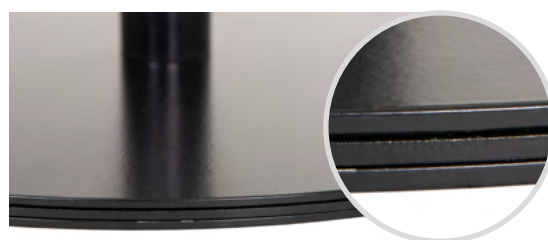

outdoor - 1 to 3 plates can be added to one post,
thus regulating its load
out door - des plaques peuvent être ajoutées pour
une stabilisation supplémentaire

Cooperate with Litex Promo Devenez notre partenaire



Interested in partnership? We offer direct factory prices and comprehensive order services and logistics. This allows you to provide customers with products and services of the highest quality. Our many satisfied distributors worldwide vouch for our unmatched expertise. We are proud of the long-lasting and constantly developed relationships with our partners, because we know that joint action brings mutual benefits. We provide timely delivery of high quality products along with excellent customer service, sales and marketing support.

Vous êtes une entreprise intéressée par un partenariat ? Nous vous proposons des prix d'usine et un service de commande et de transport complet. Cela nous permet de fournir aux clients des produits et des services de la plus haute qualité. Nous avons de nombreux distributeurs satisfaits dans le monde entier. Nous sommes fiers d'entretenir des relations durables avec nos partenaires et nous espérons les constamment développer, car nous sommes conscients que la coopération mutuelle apporte des profits réciproques. Nous assurons des livraisons dans les délais des produits d'une haute qualité ainsi qu'un excellent service client et un support marketing et commercial.

Contact

**Katarzyna Sitarek:**

ksitarek@litex.pl
+48 572 903 180

Grzegorz Płotka:

gplotka@litex.pl
+48 604 563 500

**Katarzyna Marek:**

kmarek@litex.pl
+48 604 611 426

Kamil Jabłoński:

kjablonski@litex.pl
+48 572 903 122



+48 606 120 780

Emilia Szymańska:

eszymanska@litex.pl

Iwona Kruszyk:

ikruszyk@litex.pl



+48 600 438 922

Nelli Duret:

nduret@litex.pl

Contact us and become our distributor!

Contactez-nous et devenez notre distributeur !

Legal disclaimer

Litex Promo Sp. z o.o. makes every effort to maintain the accuracy and high quality of information contained in this catalogue. However, Litex Promo is not liable for any inaccuracies or incompleteness of the information provided. The data enclosed in this catalogue is for information purposes only. It is recommended to seek professional advice regarding your specific or individual requirements, because the use of products may vary depending on the specific requirements or purpose.

Examples of finished products Litex Promo Sp. z o.o. used in the catalogue include trademarks of Litex Promo customers and are only intended to demonstrate the features and the use of advertising media. All rights to the displayed trademarks belong to their owners and are protected under the law. Litex Promo Sp. z o.o. does not derive any rights or claims against them.

Copying, editing, reproduction or undertaking other commercial or non-commercial activities, including publishing on an IT network (including the Internet), in the media, exhibitions or other places, against all or part of the content and photos posted in the catalogue is not permitted without the prior written consent of Litex Promo. The person using the Litex Promo catalogue in the aforementioned manner bears sole responsibility in the scope of observing the provisions of the copyright law, and in the case of abuse may be held liable, including compensation not only for the actual damage, but also for lost profits.

Mentions légales

Litex Promo Sp. z o.o. s'efforce de maintenir la précision et la qualité de tout le contenu de ce catalogue. Toutefois, il ne pourra être tenu responsable de l'incomplétude et/ou de l'inexactitude des informations fournies. Les informations contenues dans ce catalogue sont données à titre indicatif. Il est recommandé de demander conseil à un professionnel concernant vos besoins spécifiques ou individuels, car l'application des produits peut varier en fonction de vos exigences particulières ou de la destination du produit.

Les exemples de produits Litex Promo Sp. z o.o. utilisés dans ce catalogue présentent des marques commerciales des clients de Litex Promo et sont utilisés uniquement pour démontrer les fonctionnalités et l'utilisation prévue du support publicitaire. Tous les droits sur les marques commerciales présentées dans le catalogue appartiennent à leurs propriétaires et sont protégés par la loi. Litex Promo Sp. z o.o. ne revendique aucun droit ni prétention à ces marques.

La duplication, l'édition, la reproduction ou toutes les autres activités commerciales ou non commerciales, y compris la publication sur un réseau informatique (y compris Internet), dans les médias, lors d'expositions ou dans d'autres lieux, de la totalité ou de la partie du contenu ou des photos présentées dans le catalogue sont interdites sans autorisation écrite préalable de Litex Promo. La personne utilisant le catalogue Litex Promo de la manière susmentionnée assume seule la responsabilité dans le cadre des dispositions de la loi sur le droit d'auteur. En cas d'abus, elle peut également être tenue responsable, y compris l'indemnisation non seulement du préjudice subi, mais également du manque à gagner.



LITEX Promo Sp. z o.o.
ul. Staroprzygodzka 117
63-400 Ostrów Wielkopolski, Poland

TEL. +48 62 737 57 00 | FAX: +48 62 737 57 08
INFO@LITEX.PL | www.litex.pl